

Combined with THE LONE EAGLE, *Fighting Ace*

# THE AMERICAN EAGLE



10¢ DEC.

## HIGH RAMPARTS

A Complete Book-Length  
War-Air Novel  
Featuring The World's  
Greatest Sky Fighter  
By LT. SCOTT  
MORGAN



A THRILLING PUBLICATION



# 'I TALKED WITH GOD'

(Yes I Did - Actually and Literally)



DR. FRANK B. ROBINSON  
Founder "Psychiana," Moscow, Idaho

and as a result of that little talk with God, a strange Power came into my life. After 42 years of dismal, sickening failure, everything took on a brighter hue. It's fascinating to talk with God, and it can be done very easily, once you learn the secret. And when you do—well—there will come into your life the same dynamic, pushing Power which came into my life. The shackles of defeat and fear which bound me for years went a-shimmering—and now?—well, I own control of the largest circulating afternoon daily newspaper in North Idaho. The largest and most modern office building in my City, too. I drive a wonderful Cadillac limousine, and I own my own home which has a lovely pipe-organ in it. Moreover, my beautiful family are abundantly provided for after I'm gone. And all this has been made possible because one day, about 13 years ago, I actually and literally talked with God.

You, too, may experience that strange mystical Power which comes from talking with God, and when you do, if there is poverty, unrest, unhappiness, ill-health, or material lack in your life—well—this same Power is able to do for you what it did for me. No matter how hopeless your life seems to be—all this can be

changed. For this is NOT a human power I'm talking about—it's a God-Power. And there are no limitations to the God-Power, are there? Of course not. You probably would like to know how you, too, may talk with God, so that this same Power which brought these good things to me, might come into your life, too. Well, I have written two booklets and I have given them away, FREE, by the millions. As a matter of fact, my strange, almost unbelievable story has been told in 67 different countries, and in every city, town, village and hamlet in America. It has been written up by such outstanding periodicals as TIME, NEWS-WEEK, MAGAZINE DIGEST, and scores of other magazines and newspapers. You may have these two booklets, and you may also have illustrated circulars and letters telling what is being accomplished by your fellow men and women, who, too, have found the Power which comes from talking with God. To get them, without any obligation at all, fill in and mail to me your name and address on the form below. The name and address is Dr. Frank B. Robinson, Dept 969, Moscow, Idaho. If you ask for your copies of these booklets today, they will be sent you as soon as we receive your request here in Moscow, Idaho.

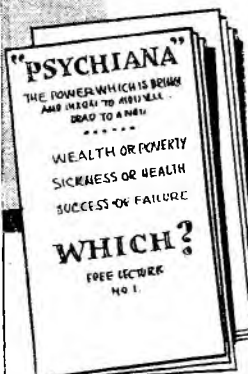

**TWO BOOKLETS FREE!**

Fill in your name and address plainly. Mail to Dr. Frank B. Robinson, Moscow,

Name.....(Print plainly, pl

Address.....

City..... State.....

(Advt. Copyright 1940. Psychiana, Inc., a non-profit religious corporation)



J. E. SMITH  
President  
National Radio Institute  
Established 25 Years

# I WILL SEND A SAMPLE LESSON FREE to PROVE I can Train You at Home in Spare Time for GOOD RADIO JOBS

## I Trained These Men



Chief Operator  
Broadcasting  
Station

"Before I completed your lessons, I obtained my Radio Broadcast Operator's License and immediately joined Station WMPC where I am now Chief Operator." HOLLIS F. HAYES, 827 Madison St., Lapeer, Michigan.

Makes \$50  
a Week

"I am making around \$50 a week after all expenses are paid, and I am getting all the Radio work I can take care of, thanks to N. R. I." H. W. SPANGLER, 1261 1/2 S. Gay St., Knoxville, Tenn.



\$5 to \$10  
Week in  
Spare Time

"I am engaged in spare time Radio work. I average from \$5 to \$10 a week. I often wished that I had enrolled sooner because all this extra money sure does come in handy." THEODORE K. DuBREFF, Horsham, Penn.



### Extra Pay in Army, Navy, Too

Every man likely to go into military service, every soldier, sailor, marine, should mail the Coupon Now! Learning Radio helps men get extra rank, extra prestige, more interesting duty at pay up to 6 times a private's base pay. Also prepares for good Radio jobs after service ends. IT'S SMART TO TRAIN FOR RADIO NOW!

Here is a quick way to better pay. Radio offers you the opportunity to make \$5, \$10 a week extra in spare time a few months from now and to prepare for good full-time Radio jobs paying up to \$50 a week. MAIL COUPON. Get my Sample Lesson FREE. Examine it, read it—see how easy it is to understand. See how I train you at home in spare time to be a Radio Operator or Radio Technician.

**REAL OPPORTUNITIES FOR BEGINNERS  
TO LEARN THEN EARN UP TO \$50 A WEEK**  
Broadcasting stations (882 in the U. S.) employ thousands of Radio Technicians with average pay among the country's best paid industries. Repairing, servicing, selling home and auto Radio receivers (there are 50,000,000 in use) gives good jobs to thousands. Many other Radio Technicians take advantage of the opportunities to have their own service or retail Radio businesses. Think of the many good-pay jobs in connection with Aviation, Commercial, Police Radio and Public Address Systems. N. R. I. gives you the required knowledge of Radio for those jobs. N. R. I. trains you to be ready when Television opens new jobs. Yes, Radio Technicians make good money because they use their heads as well as their hands. They must be trained. Mail the COUPON, NOW!

### I'LL SHOW YOU HOW TO MAKE \$5, \$10 A WEEK EXTRA IN SPARE TIME WHILE LEARNING

Nearly every neighborhood offers opportunities for a part time Radio Technician to make good money fixing Radio sets. I give you special training to show you how to start cashing in on these opportunities early. You get Radio parts and instructions for building test equipment, for conducting experiments that give you valuable, practical experience. You also get a modern Professional Radio Servicing Instrument. My fifty-fifty method—half working with Radio parts, half studying my Lesson Texts—makes learning Radio at home interesting, fascinating, practical.

### FIND OUT HOW I TRAIN YOU AT HOME FOR GOOD PAY IN RADIO

MAIL THE COUPON. I'll send you a Sample Lesson and my 64-page book FREE. Learn about my Course; the types of jobs in different branches of Radio. Read letters from more than 100 men I have trained so you can see what they are doing, earning. MAIL THE COUPON in an envelope or paste it on a penny postal.

J. E. Smith, President  
Dept. 1N09, National Radio Institute  
Washington, D. C.



BROADCASTING STATIONS (top illustration) employ Radio Technicians as operators, installation, maintenance men and in other fascinating, steady, well-paying technical jobs. FIXING RADIO SETS (lower illustration) pays many Radio Technicians \$30, \$40, \$50 a week. Others hold their regular jobs and make \$5 to \$10 a week extra in spare time.

Mail Coupon  
Now!



This FREE BOOK has Helped Hundreds  
of Men to Make More Money

Mr. J. E. Smith, President, Dept. 1N09  
NATIONAL RADIO INSTITUTE, Washington, D. C.

Mail me FREE, without obligation, your Sample Lesson and 64-page book  
"Rich Rewards in Radio." (No Salesman will call. Please write plainly.)

Name..... Age.....

Address.....

City..... State..... 2FRS



EVERY STORY BRAND NEW

Combined with THE LONE EAGLE, Fighting Ace

# THE AMERICAN EAGLE

Vol. XXIII, No. 3

BRUCE McALESTER, Editor

December, 1941

A Full-Length War-Air Action Novel

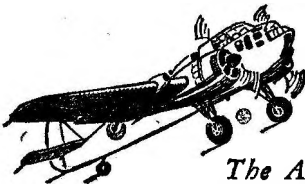

## HIGH RAMPARTS

By LIEUT. SCOTT MORGAN

*The American Eagle Fights a One-Man War Against a Death-Dealing New Secret Weapon! Follow John Masters as He Roars Over Iceland to Protect the Soldiers of the United States*

15

### Zooming Short Stories

- WINGS OF SAND . . . . . Robert Sidney Bowen 67  
*Barry Grey, Yank Pilot, Flies Over The Sahara in Search of a Bandit*
- BIRD FEUD! . . . . . Joe Archibald 78  
*Ambrose and Muley Get Themselves Out on a Limb*
- MURDER'S SO SORRY . . . . . Laurence Donovan 94  
*Two American Air Instructors Run into Grim Jap Strategy*

### Special Flying Features

- AROUND THE HANGAR . . . . . The Wing Commander 10
- THE L. E. A. FLYING COURSE . . . . . Bruce McAlester 64  
*A Lesson on the Subject of Liquid-Cooled Motors*
- THE STORY OF THE COVER . . . . . Illustration and Text 77
- THE SHIP OF THE MONTH . . . . . Illustrated Feature 89  
*The North American Five-Place Attack Bomber NA-40-A*
- MODEL FIGHTING SHIPS . . . . . Builders' Plans 90  
*How to Build the Nieuport 17 C. 1*

Join Our Nation-wide Club for Air Fans! Coupon on Page 112

See Pen Pals, Page 109; Swap Column, Page 113

THE AMERICAN EAGLE, published every other month by BETTER PUBLICATIONS, INC., at 10 East 40th Street, New York, N. Y. N. L. Pines, President. Entire contents copyrighted, 1941, by Better Publications, Inc. Subscription yearly, \$3.60; single copies, \$1.10; foreign and Canadian, postage extra. Entered as second-class matter June 22, 1938, at the Post Office at New York, N. Y., under the Act of March 3, 1879. Names of all characters used in stories and semi-fiction articles are fictitious. If the name of any living person or existing institution is used, it is a coincidence. Manuscripts must be accompanied by self-addressed, stamped envelope, and are submitted at the author's risk.

READ OUR COMPANION AIR MAGAZINES: SKY FIGHTERS, R A F ACES, AND AIR WAR

PRINTED IN THE U. S. A.



# AMAZINGLY EASY WAY TO GET INTO ELECTRICITY

*I'll Finance Your Training*

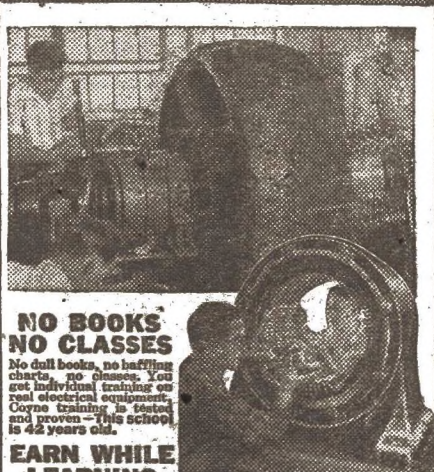

## NO BOOKS NO CLASSES

No dull books, no huffing charts, no classes. You get individual training on real electrical equipment. Coyne training is tested and proven—this school is 42 years old.

## EARN WHILE LEARNING

If you need part-time work to help pay your living expenses I'll help you get it. Then, in 12 brief weeks, in the great roaring shops of Coyne, I train you as you never dreamed you could be trained... on one of the greatest outlays of electrical apparatus ever assembled, real dynamos, engines, power plants, autos, switchboards, transmitting stations... everything from doorbells to farm power and lighting... full-sized... in full operation every day!

## PREPARE FOR JOBS LIKE THESE

Armature Winder  
Sub-Station Operator  
Auto & Aviation Ignition  
Maintenance Electrician  
Service Station Owner  
Air Conditioning  
Electric Refrigeration  
Radio Servicing  
and many others

Our Employment Bureau for graduates gives FREE lifetime employment service.

## Learn Without Books in 90 DAYS

Get into the fascinating, fast growing, well paid field of Electricity—a field that offers you opportunities and a future—in good times and bad times—a field that is a permanent necessity in prosperity or depression. Here is your chance to prepare yourself for a lasting permanent future.

Here at Coyne, in 90 days, you can train for your Big Opportunity by working on real electrical machinery. Here you learn airplane ignition, wind armatures, learn power plant operation, do house and factory wiring, etc. Coyne training is easy to learn. You "Learn-By-Doing", not by books. Not a correspondence course. You don't need previous experience or advanced education. With this brief description of my school I want to bring out this important fact—you don't need much money to get my training. I have many plans to help the fellow who needs training but hasn't much money. Read all of this advertisement—then mail coupon for all the facts.

## MAIL COUPON FOR FREE BOOK

I want to tell you my complete story—how I have helped hundreds of other fellows get good-pay jobs and how I can help you. I want to send you your copy of my Big FREE Book, packed with pictures of students at work in my shops. I want to tell you how you can "earn while learning" and how I give my graduates free employment service for life. Send for my complete story. No obligation. No salesman will call. Mail coupon today.

**H. C. LEWIS, COYNE ELECTRICAL SCHOOL**  
President  
500 S. Paulina St. Dept. 91-84 CHICAGO, ILLINOIS

H. C. Lewis, President;  
COYNE ELECTRICAL SCHOOL;  
500 S. Paulina St., Dept. 91-84 Chicago, Ill.

Please send me your Big FREE Book and all the facts about Coyne and your plans to help fellows like me get ahead.

**GET YOUR TRAINING  
NOW... PAY FOR  
IT LATER!**

Don't let lack of money hold you back. If you are between the ages of 16 and 40, you can get this training first and pay for it in 12 monthly payments—beginning 60 days after your training period ends. You'll be amazed at how little money you need to get Coyne training. If you need part-time work to help out with living expenses while you train, my employment department will help you find it. Lifetime employment service after you graduate. Mail coupon for all the facts.

Home of  
Coyne  
Electrical  
School



H. C. Lewis

**EASY TO  
LEARN-  
EASY TO  
PAY**

NAME.....  
ADDRESS.....  
CITY.....STATE.....



# Play the melody of "KISS THE BOYS GOODBYE" — right now!

so dad-dy let me stay out late

Just strike the notes indicated above, and you'll be actually playing the melody of the popular hit tune of Paramount's picture, "Kiss the Boys Goodbye," starring Mary Martin and Don Ameche.

Copyright 1941 by Famous Music Corp.



Prove to yourself how easy it is  
to play the piano or any  
other instrument

## for as little as 7¢ a day

SIT DOWN at a piano right now and see how easily you can pick out the melody of "Kiss the Boys Goodbye," following the simple diagram above. And you can do the same thing with other popular melodies, too, when you use the wonderful "Note-Finder" that guides your hands on the keyboard.

This invention of the U. S. School of Music takes the mystery out of the piano keyboard, does away with tedious study and practice, enables anyone to play a real tune almost from the start. And that's the way this modern method works. You learn to play by *playing*. Soon you will be thrilled and delighted to find that you can pick up almost any piece of popular music and play it at sight. And that applies to the piano or violin, the saxophone or guitar, the accordion or whichever instrument you choose for your own!

### Takes Only Few Minutes a Day!

Do you wonder that over 700,000 people all over the world have taken advantage of this easy way to learn music at home? Don't let old-fashioned ideas deprive you of the joys of playing any longer. You don't need special talent; you don't need any previous knowledge of music; you don't need to spend months on monotonous drills and exercises. It's fun to learn music this modern way; it's easy as A-B-C; it takes only a few minutes a day. But see for yourself! Simply send today for our

### Free Print and Picture Sample

This Print and Picture Sample will give you the surprise of your life. It will show you, in black and white, how you can quickly realize your dreams of playing your favorite instrument. With the Print and Picture Sample you will also receive a handsome illustrated booklet and details of the remarkable, money-saving offer that enables you to learn music at home for but a few cents a day. All this material will be sent to you by return mail. If interested, mail the coupon or write, mentioning instrument of your choice. Do it *today*. Note: instruments supplied when needed, cash or credit. U. S. School of Music, 29412 Brunswick Bldg., New York City, N. Y. (Est. 1898.)

U. S. School of Music, 29412 Brunswick Bldg., New York, N. Y.  
I am interested in learning the musical instrument indicated below.  
Please send me your free illustrated booklet, "How to Learn Music at Home," and the free Print and Picture Sample.

Piano	Mandolin	Trombone	Piano Accordion
Violin	Saxophone	Banjo	Plain Accordion
Guitar	Trumpet	Ukulele	Hawaiian Guitar
Cello		Cornet	Other Instrument

Have You Instrument? .....

Name .....

Address .....

City ..... State .....

Check here if under 16 years of age.



# 15 Minutes a Day!

Give me just this  
and I'll prove I can make you  
**A NEW MAN!**

I'M "trading-in" old bodies for new! I'm taking men who know that the condition of their arms, shoulders, chests and legs—their strength, "wind," and endurance—is not 100%. And I'm making NEW MEN of them. Right now I'm even training hundreds of soldiers and sailors who KNOW they've got to get into shape FAST!

## Only 15 Minutes a Day

Are you ALL MAN—tough-muscled, on your toes every minute, with all the up-and-at-'em that can lick your weight in wildcats? Or do you want the help I can give you—the help that has already worked such wonders for other fellows, everywhere?

All the world knows I was ONCE a skinny, scrawny 97-pound, weakling. And NOW it knows that I won the title, "The World's Most Perfectly Developed Man." Against all comers! How did I do it? How do I work miracles in the bodies of other men in only 15 minutes a day. The answer is *Dynamic Tension*, the amazing method I discovered and which changed me from a 97-pound weakling into the champion you see here!

In just 15 minutes a day, right in the privacy of your own home, I'm ready to prove that *Dynamic Tension* can lay a new outfit of solid muscle over every inch of your body. Let me put new, smashing power into your arms and shoulders—give you an armor-shield of stomach muscle that laughs at punches—strengthen your legs into real columns of surging stamina. If lack of exercise or wrong living has weakened you inside, I'll get after that condition, too, and show you how it feels to LIVE!



*Charles Atlas*

—actual photo of the man who holds the title, "The World's Most Perfectly Developed Man."

Charles Atlas—America's Greatest "Builder of Men"

Among all the physical instructors and "conditioners of men" ONLY ONE NAME STANDS OUT. That name is Charles Atlas!

In every part of the country Charles Atlas is recognized as "America's Greatest Builder of Men." Almost two million men have written to him. Thousands upon thousands have put their physical development into his capable hands!

And now that the call is for men capable of helping America meet and conquer any national emergency, many thousands of others (even those already in their country's Army and Navy) are calling upon Charles Atlas to build the kind of men America vitally needs.

MAIL THIS COUPON NOW!

**FREE** This Famous Book that Tells You How to Get a Body that Men Respect and Women Admire

Almost two million men have sent for and read my book, "Everlasting Health and Strength." It tells you exactly what *Dynamic Tension* can do. And it's packed with pictures that SHOW you what it does. RESULTS it has produced for other men. RESULTS I want to prove it can get for YOU! If you are satisfied to take a back seat and be pushed around by other fellows week-in, week-out, you don't want this book. But if you want to learn how you can actually become a NEW MAN, right in the privacy of your own home and in only 15 minutes a day, then man!—get this coupon into the mail to me as fast as your legs can get to the letterbox! CHARLES ATLAS, Dept. 77 M, 115 East 23rd St., New York City.

CHARLES ATLAS, Dept. 77 M  
115 East 23rd St., New York City

I want the proof that your system of "Dynamic Tension" will help make a New Man of me—give me a healthy, husky body and big muscular development. Send me your free book, "Everlasting Health and Strength."

Name.....  
(PLEASE PRINT OR WRITE PLAINLY)

Address.....

City..... State.....



*Bankers Life and Casualty Company*

OFFERS THE NEW

**FAMILY GROUP POLICY**

THAT

**Insures Entire Family**



The Murray Family, 4712 Leamington Ave., Chicago, Ill.

**10 DAY  
FREE OFFER**

**Mail Coupon!**

**Send No Money**

**TOTAL  
COST**

*Only*

**\$1.00**

**A MONTH  
FOR ALL!**

**Baby-Children-Parents-Grandparents**

AS PLAINLY STATED IN THE POLICY

**YOUR ENTIRE FAMILY  
IS INSURED UP TO:**

**\$1,000.00**

Maximum—For Natural Death

**\$2,000.00**

Maximum—For Auto Accidental Death

**\$3,000.00**

Maximum—For Travel Accidental Death

The policy is not cancelled by the death of one of the insured members. The benefits are paid and the policy remains in force on the balance of the insured group as long as premiums are paid. Monthly premiums are divided equally between the number insured and benefits are graded according to the attained ages of members insured.

**AGES 1 TO 75... at Same Cost!**

This wonderful Family Group policy now gives your whole family safe, reliable insurance, paying benefits for natural death, double amount for auto accidental death, and triple benefits for travel accidental death. One policy, one premium insures all your loved ones—baby to grandparents—all for only \$1.00 per month!

**NO MEDICAL EXAMINATION**

We have thousands of satisfied policyholders all over the country, many of whom could not afford to pay big prices. Now YOUR ENTIRE FAMILY can enjoy real life insurance protection. No agent will call. No medical examination, no investigation, no red tape. This remarkable Triple Indemnity policy sold by mail on Bankers Life and Casualty Company's ironclad guarantee. You take no risk!

**SEND NO MONEY**

Remember, you do not send one cent with coupon—just your name and address, and we send you our 10 Day Free offer and full details. Be sure to write today. Don't put this off. Just mail coupon. No obligation.

**NO AGENT  
WILL CALL**

Send coupon quick for full details and our 10 Day Free offer. No obligation or single penny expense to you. Act today for this new low cost family group policy.

**MAIL TO GET  
DETAILS FREE!**

**BANKERS LIFE AND CASUALTY CO.**  
Bankers Insurance Bldg., Jefferson Sta., Desk 70, Chicago, Ill.  
Please send details and tell me how to get the Family Group Policy for free inspection. No Agent Will Call.

Name .....

Street or R. F. D. ....

City .....

**ACT NOW • SEND COUPON!**



WORLD'S LARGEST DENTAL PLATE MAKERS

# FALSE TEETH

**\$7<sup>95</sup>**  
to \$35

by  
**MAIL**



Posed by a Professional Model

**SEND NO MONEY!**

BEFORE

AFTER



Mrs. Elsie Boland of Norton, Kansas, writes:

"Enclosed find two pictures. One shows how I looked before I got my teeth; the other one afterwards. Your teeth are certainly beautiful. I have not had mine out since the day I got them, except to clean them."

**MADE - TO - MEASURE  
DENTAL PLATES DIRECT FROM OUR  
LABORATORY TO YOU!**

We make to measure for you individually—BY MAIL—Dental Plates for men and women—from an impression of your own mouth taken by you at your home. We have thousands of customers all over the country wearing teeth we made by mail at sensible prices.

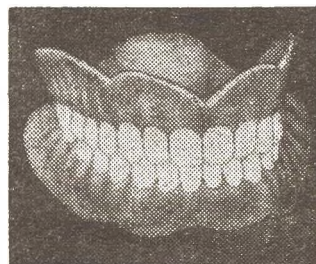

HAND-CARVED SET

**AT ROCK-BOTTOM  
PRICES**

If you find out what others have paid for theirs, you will be astounded when you see how little ours will cost you! By reading our catalog, you will learn how to save half or more on dental plates for yourself. Monthly payments possible.



PARTIAL

**ON 60 DAYS' TRIAL**

Make us prove every word we say. Wear our teeth on trial for as long as 60 days. Then, if you are not perfectly satisfied with them, they will not cost you a cent.

**WITH MONEY - BACK  
GUARANTEE OF  
SATISFACTION**

We take this risk. We guarantee that if you are not completely satisfied with the teeth we make for you, then any time within 60 days we will immediately refund every cent you have paid us for them. We take your word. You are the judge.

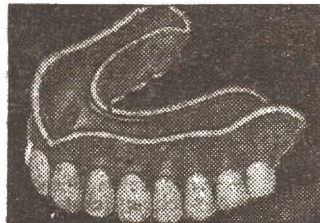

ROOFLESS

**HIGH-GRADE MATERIAL AND EXPERT  
WORKMANSHIP**

TRY our practically unbreakable ROOFLESS, PARTIAL and TRANSLUCENT plates. Our dentures are set with pearly-white, genuine, porcelain teeth; constructed from high-grade materials, with expert workmanship. We make all styles of plates. A dentist supervises the making of each plate. . . .

MAIL THIS COUPON NOW

**FREE UNITED STATES  
DENTAL COMPANY**

Dept. C-82, 1555 Milwaukee Ave.,  
CHICAGO, ILLINOIS.

Send, without obligation, your FREE impression material, catalog, and information.

NAME.....

ADDRESS.....

(Print Clearly)



Harry Willoughby, Adairville, Kentucky, writes:

"I have received my teeth and am PROUD OF THEM."



Mrs. Geo. G. Conkle, Bridgeport, Connecticut, writes:

"I received my set of teeth. I wear them, day and night. I have good reason to be well pleased with them. Thank you very much."

The foregoing are a few of thousands of unsolicited letters. We do not imply that you will obtain the same results. What is important to you is WE GUARANTEE YOUR MONEY BACK IF YOU ARE NOT 100% SATISFIED.

**FREE**

IMPRESSION MATERIAL. Catalog with our new low prices and information. Don't put this off. Do it TODAY! CLIP COUPON OR WRITE. A one cent postcard with name and address plainly written is all that is necessary.

We also Repair or Reproduce Old Plates—48-hour Service

**UNITED STATES DENTAL COMPANY**

1555 Milwaukee Ave., Dept. C-82, Chicago, Ill.



# Around the Hangar



A Department

for Readers

**M**OVE over, pilots, and let us in here. We realize that we are only the wing-commander around this hangar but be democratic and tolerate us for a while. Take our luggage, Creepy, and be careful with it as we do not want it to start leaking. Oh, it is only a bottle of hair tonic we got for answering tough air questions on a famous radio program. Make room for Oswald as he will be with us this meeting. Wait until you hear where we have been.

Oswald and yours truly have just got back from Lowry Field, Denver, where we watched the U. S. Air Corps snap pictures and develop them. We met Lieutenant-Colonel George Goddard there and we asked him did he remember being a cartoonist on the Chicago Solvay-Coke house organ back in 1917 and 1918? The Lt.-Col. was staggered at us having such a memory and from then on Oswald and your C. O. owned the joint.

## Pictures While You Wait

Oswald had his girl Mona Lott with him and it was the only drawback to the trip.

Mona took a gander at the flying developing lab in one of the observation crates and was amazed at such efficiency. "Everythin' they got here, Oswald," she piped. "Only one thing missin' that I always git when I go to get films developed. A glass of coke. Otherwise it makes me think of Derby's drug store in Willimantic. Don't it you?"

We shut Mona up and let them show us the workings of the T-3A cameras that are mounted in tandem at forty-five degree angles to each other so that it makes an octagonal picture.

If a plane flying as high as 25,000 feet snapped such a photo, it would take an area of 550 square miles. The T-3A takes one vertical picture and eight oblique shots. The Air Corps flying research lab can photograph, develop and print a picture in less than five minutes and so look back to the last guerre and think about the time consumed before a snap of a section of Heinie linoleum reached the brass hats at divisional or battery headquarters.

A far cry from the day that your correspondent went up in a Jenny at San Antonio to actually sketch terrain with paper and pencil!

Air Corps Kodaks record dial readings during test flights. While the pilot blacks out, the camera clicks and regis-

ters the result of the dive on the panel instruments.

Yes, they are experimenting with color films at Lowry Field. They tried a costly experiment there, ran a wingless pursuit ship against a brick wall and watched the flames spurt out. But the naked eye was unable to spot the place in the fuselage the first stripe of fire belched out of.

The camera picked out the spot, the movies showing a thin red streak of fire at the hottest part of the fuselage. The fire, they proved, started near the ignition switch. We hope that an army observation-crate crew will ultimately get us a photo of Hitler running for the woods. A colored one.

## Welcome Home

Horace is out there grazing as you all can see. He was sent back collect. The big shots at the Naval Academy threatened to open up Horace before they crated him up, to get the gold stripes out of him. Horace got hold of the uniforms of two admirals, a lieutenant-commander and a captain and left them as nude of gold stripes as a prisoner at the Mare Island navy klink out on the Pacific coast. Horace also ate the commandant's mess coat.

You can't please some guys and anyway, there is no sense of humor down there.



Just for the mean letter we got from Annapolis, we hope the cadets win in November by the score of 109-0.

## Page Secretary Ickes

The flying fortress carries ten thousand gallons of 100-octane gas, several thousands more gallons than a railway tank car. The big bomber would empty its tanks once a day if engaged in active service. Figure it out. How much of the fuel would fifty to eighty thousand planes consume in the event of a war? One in every ten a long-range bomber! So a lot of us kick

(Continued on page 12)



# don't Worry about Rupture

Why put up with days . . . months . . . YEARS of discomfort, worry and fear? Learn now about this perfected invention for all forms of reducible rupture. Surely you keenly desire—you eagerly CRAVE to enjoy life's normal activities and pleasures once again. To work . . . to play . . . to live . . . to love . . . with the haunting Fear of Rupture banished from your thoughts! Literally thousands of rupturesufferers have entered this Kingdom of Paradise Regained. Why not you? Some wise man said, "Nothing is impossible in this world"—and it is true, for where other trusses have failed is where we have had our greatest success in many cases! Even doctors—thousands of them—have ordered for themselves and their patients. Unless your case is absolutely hopeless, do not despair. The coupon below brings our Free Rupture Book in plain envelope. Send the coupon now.

## Patented AIR-CUSHION Support Gives Nature a Chance to CLOSE the OPENING

Think of it! Here's a surprising yet simple-acting invention that permits Nature to close the opening—that holds the rupture securely but gently, day and night, at work and at play! Thousands of grateful letters express heartfelt thanks for results beyond the expectation of the writers. What is this invention—How does it work? Will it help me? Get the complete, fascinating facts on the Brooks Automatic Air Cushion Appliance—send now for free Rupture Book.

## Cheap—Sanitary—Comfortable

Rich or poor—ANYONE can afford to buy this remarkable, LOW-PRICED rupture invention! But look out for imitations and counterfeits. The Genuine Brooks Air-Cushion Truss is never sold in stores or by agents. Your Brooks is made up, after your order is received, to fit your particular case. You buy direct at the low "maker-to-user" price. The perfected Brooks is sanitary, lightweight, inconspicuous. Has no hard pads to gouge painfully into the flesh, no stiff, punishing springs, no metal girdle to rust or corrode. It brings heavenly comfort and security—while the Automatic Air Cushion continually works, in its own, unique way, to help Nature get results! Learn what this patented invention can mean to you—send coupon quick!



C. E. BROOKS,  
Inventor

## SENT ON TRIAL!

No . . . don't order a Brooks now—FIRST get the complete revealing explanation of this world-famous rupture invention, THEN decide whether you want the comfort—the freedom from fear and worry—the security—the same amazing results thousands of men, women and children have reported. They found our invention the answer to their prayers! Why can't you? And you risk nothing as the complete appliance is SENT ON TRIAL. Surely you owe it to yourself to investigate this no-risk trial. Send for the facts now—today—hurry! All correspondence strictly confidential.

## FREE! Latest Rupture Book Explains All!

Sent You In Plain Envelope Just Clip and Send Coupon ➔

Brooks Appliance Co., 182A State St., Marshall, Mich.

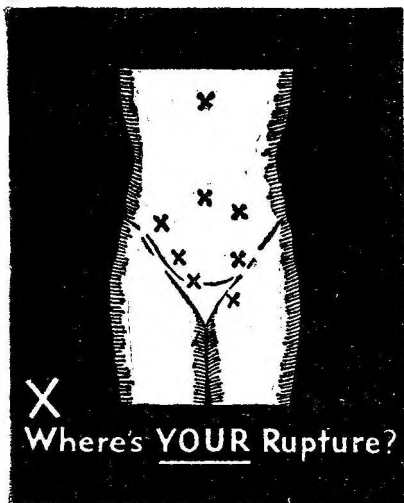

## PROOF!

Proof of the value and outstanding merit of the BROOKS APPLIANCE is clearly shown by the fact that over 9000 doctors have ordered it for themselves or their patients. One doctor alone has ordered for his patients over 400 Brooks Appliances. Follow your doctor's advice! If he says you have a reducible rupture and advises a proper-fitting support, don't subject yourself to further delay, which may prove dangerous, but send us your name and address immediately. Stop Your Rupture Worries! Enjoy the comfort, freedom of action and physical security which this made-to-order appliance will give you.

## Mail This Coupon NOW!

**BROOKS APPLIANCE CO.**  
182-A State St., Marshall, Mich.

Without obligation, please send your FREE Book on Rupture, Proof of Results, and TRIAL OFFER—all in plain envelope.

Name \_\_\_\_\_

Street \_\_\_\_\_

City \_\_\_\_\_ State \_\_\_\_\_

State whether for Man  Woman  or Child



# WANTED

**MEN and WOMEN**  
**WORK for the U. S. GOVERNMENT**  
**Salaries \$1700 - \$2600 Per Year**  
**NO LAYOFFS! VACATIONS WITH PAY!**  
**PENSIONS! REGULAR RAISES!**

## A LIFETIME JOB

**RAILWAY POSTAL CLERKS**  
 City Mail Carriers Clerks-File Clerks  
 Post Office Clerks Steno-Typists  
 Rural Mail Carriers Customs Inspectors  
**PATROL AND IMMIGRATION INSPECTORS**

**Pay for Course Only**  
**After You Are**  
**Appointed and Working**

So sure are we that our simplified Interstate Home Study Course of coaching will result in your passing the Government examination and being appointed, that we are willing to accept your enrollment on the following basis. The price of our complete 16 week lesson course is \$30, plus \$3 Examiners' Fee.

We are willing to give you any course with the understanding that you are to pay for it ONLY AFTER YOU ARE APPOINTED AND WORKING FOR THE GOVERNMENT.

**FULL Particulars FREE!**

----- Clip and Mail this Coupon NOW -----  
**INTERSTATE HOME STUDY ACADEMY T-10**  
 901 Broad St., Div T-10, Newark, New Jersey  
 Please BUSH me FREE particulars, without obligation, how to qualify for a Government Job.

Name .....

Address .....

City ..... State .....

**GLASSES**  
 as LOW as  
**\$1.95 PAIR**

**16 DAYS TRIAL**

Choice of the LATEST STYLES—remarkably LOW PRICES. SATISFACTION GUARANTEED or your money back. If you are not satisfied—they will not cost you a cent.

**SEND NO MONEY** Write for FREE catalog today showing all of our many styles and LOW prices!

**ADVANCE SPECTACLE CO.** BROKEN GLASSES REPAIRED AT LOW COST!

597 S. Dearborn St., Dept. T-10 Chicago, Ill.

## "RHEUMATIC PAINS" MAKE THIS TEST FREE

If you'll just send me your name and address, I'll mail you ABSOLUTELY FREE a generous trial test supply of the NEW IMPROVED CASE COMBINATION METHOD for relief of those agonizing pains commonly associated with RHEUMATIC, SCIATICA, ARTERIO, and NEURALGIC conditions. No matter how long you have had those awful pains you owe it to yourself and your dear ones to try my new improved Case Combination Method. IT DOESN'T COST YOU ONE PENNY TO TRY IT, SO SEND YOUR NAME AND ADDRESS TODAY.

**PAUL CASE, Dept. 448 Brockton, Mass.**

**MOUNT BIRDS**

**Tan SKINS, Make Up FURS**

Be a Taxidermist. Double your hunting fun. We teach you at Home. Mount Birds, Animals, Pets, Heads and Fish. Save your hunting trophies. Decorate home and den. MAKE MONEY. Mount and compete for others. Big spare-time profit. INVESTIGATE TODAY.

**FREE BOOK with 100 game pictures, 42 pages.** Get your copy today. This Minute! State your AGE.

**Send postal card TODAY -- This Minute! State your AGE.**

**NORTHWESTERN SCHOOL OF TAXIDERMISTRY, Dept. 4172, Omaha, Neb.**

## AROUND THE HANGAR

(Continued from page 10)

about rationing gas for our insignificant jalopies!

Thousands of young sprouts shudder at the thought of walking as far as six blocks but let them think of the refugees walking the roads of devastated Europe. Have they flivvers to ride in? They would sell their souls for a balky horse.

A lot of us lucky Americans waste too much gas, verbally and mechanically.

### Dear Diary

All Americans should read the book, *I Was a Nazi Flyer*. If it is one hundred percent authentic, then Jerry flyers are not one big happy family.

Seems strange to us that any member of the Luftwaffe would be allowed to keep such a record of his sojourn on a Heinkel Heinkel field. You will read where the author, a Mr. Leske, differed with his comrades regarding Nazi philosophy and Nazi leadership. Leske openly criticizes certain bigwigs of the Reich in his diary and we are amazed that the Gestapo did not throw their hooks into the Nazi, for one or two of Leske's flying mates knew of the record he kept.

They seemed incredible to us, parts of Leske's book. He gave the impression that he and a lot of his Luftwaffe pals had the mentality of morons. He admitted that there was a jealous rivalry between bombing squadrons and pursuit squadrons. Does that make for unity in the Third Reich? All in all, the book gave little proof that the Germans are a master race. Read it. You will be convinced more than ever that Hitler is going to get a pasting.

### Help!

If you can't get into the air corps where they fly the big ones with the high-powered engines, try the glider corps. We've got to have one and a big one before many more blitzes take place in Europe. Air journals report that the Nazis have at least 500,000 pilots with glider experience. Russia has 600,000.

The taking of Crete proved that the glider will play a big part in air fighting in the next few years. Up to the time Hitler grabbed the Balkans, glider interest in this country reached a low ebb. Now we are feverishly trying to think up ways to encourage the glider enthusiasts.

In 1941, Congressmen introduced five bills to get government support for these soarers. We look back to the meets we attended at Elmira and Ellenville, N. Y., where we saw glider pilots wondering how they could eat and still haul their crate around the country at the same time.

Believe me, gentlemen, the glider pilots have been the "Okies" of the aviation industry. There is unwarranted opposition to the training of glider pilots in Washington. It should not last. Who elects some of those Congressmen, anyway?

### The Chickens Are Home to Roost

"They can't hurt us," the manager of a slap-happy pug often tells his punching-



bag between rounds. "Bombs won't ever fall on you," Hitler and Goering assured their regimented stooges. My, my, what a surprise the folks in Berlin and a hundred other big towns in Germany must be getting.

The R. A. F. are pounding the Reich from dawn until dusk and every day the R. A. F. uses more planes to do the shelling and every day brings more bombers from the United States to embattled Britain. A different picture than a year ago. We wonder if Goering and Adolf visit the stricken areas the way the King and Churchill do?

German morale against English morale. Another front where the war might be won. Let them see the havoc their brave Luftwaffe pilots wrought in London and Coventry. Let the misguided people of Berlin see the dead and dying. Let them pull the little tots out from under the ruins. It is the only language Hitler understands, bomb for bomb. Keep them flying. Keep them dropping.

**Air Mail**

Well, where is the sack of mail for this rendezvous with destiny? Who knows but what the next president of the U. S. is writing to us and that his letter is in this



batch. Her letter? Who said that? Well, could possibly be, that the distaff side will take over the world. The males have made an awful mess of it.

Here is Creepy Cruger with the mail, so everybody get out of the way and let us sort it. We are responsible for you buzzards and maybe one of the packages there has a bomb in it.

Speaking of Amazon rule in the future, here is one to start off with. Maria Raffo of Grove Rd. and West Blvd., Vineland, N. J. Maria has some stamps and wants to use them up on some deserving pen pals. But let her speak for herself:

My girl friend introduced me to THE AMERICAN EAGLE magazine about a year ago, and I've read it ever since.

I'm fifteen and would like to be listed as a pen pal. I promise to answer all letters received. I have already enlisted as a member. Thank you.

All right, it is a promise you made, Maria. We will try and get you a mailing list but why are all you nice girls only fifteen? We get lonesome, too, and if there is any rich widow who owns a Stinson and is not more than thirty-five, well our address is always in the magazine. But business must go on so let's have a squint at this short

(Continued on page 103)

*Not Expensive to Learn*  
**SCIENTIFIC CRIME DETECTION**  
*The Steady Pay Profession*  
*Good Times—or Bad*

"I will teach you Finger Print Identification — Firearms Identification—Police Photography—and Secret Service!" That's what I told the men who now handle the good jobs listed in the column at the right. Give me a chance and I'll train YOU to fill an important position in the fascinating field of scientific crime detection.

*Learn*  
**FINGER PRINTING**  
**FIREARMS IDENTIFICATION**  
**POLICE PHOTOGRAPHY**  
**SECRET SERVICE METHODS**



**I TRAINED THE MEN WHO THEN GOT THESE BIG JOBS**

Here are a few of the 750 bureaus headed by our students and graduates.

- STATE BUREAU OF DELAWARE
- STATE BUREAU OF FLORIDA
- STATE BUREAU OF MAINE
- STATE BUREAU OF MICHIGAN
- STATE BUREAU OF NEW MEXICO
- STATE BUREAU OF RHODE ISLAND
- STATE BUREAU OF SOUTH CAROLINA
- STATE BUREAU OF TEXAS
- STATE BUREAU OF UTAH
- LINCOLN, NEBRASKA
- CONCORD, N. H.
- ALBANY, N. Y.
- TRENTON, N. J.
- CANTON, OHIO
- TULSA, OKLA.
- MOBILE, ALA.
- PHOENIX, ARIZ.
- LOS ANGELES, CALIF.
- SEATTLE, WASH.

**GET IN NOW!**

But don't be misled. Scientific crime detection is not simple. It's a science—a real science, which requires very special training. I teach you this science so that you should be competent to do the work of a thoroughly trained employee in a bureau of identification, for the rest of your life. I give you something nobody can ever take from you.

**LOOK AT THE RECORD!**

43% of ALL Identification Bureaus in the United States are headed by our students and graduates. They have regular jobs—salaries—often collect reward money—and many of these men knew absolutely nothing about this work before they began their training with me.

**FREE BLUE BOOK OF CRIME**

This book is full of exciting information on scientific crime detection. It will show YOU how YOU, at a cost so low you shouldn't even think of it, can get started without delay. Don't wait. Clip coupon... send it NOW!

**INSTITUTE OF APPLIED SCIENCE**  
 1920 Sunnyside Ave. Dept. 7969 Chicago, Ill.

INSTITUTE OF APPLIED SCIENCE  
 1920 Sunnyside Ave., Dept. 7969, Chicago

Gentlemen: Without any obligation on my part, send me the "Blue Book of Crime," and complete list of 750 bureaus employing your graduates, together with your low prices and Easy Terms Offer. (Literature will be sent ONLY to persons stating their age.)

Name.....

Address.....

Age.....



**THE "SOVEREIGN OF THE SEAS"** could show her stern to any square-rigger...sailed 1478 miles in four days back in 1853! In those days captains lashed kegs of whiskey to quarterdecks . . . where the pitching motion *rocked* it to smoother flavor.

**Try Rocking Chair...smooth and mellow as the wave-rocked whiskeys that inspired it!**



**RETIRED**, these old salts "rocked the keg"—with a rocker replacing the briny deep! Mr. Boston took a leaf from their log! The *Rocking Chair Whiskey* he brings you today was inspired by famous "rocked" whiskeys of yore.



**MR. BOSTON RECAPTURES** the long-forgotten mellowness of whiskeys "rocked in the keg" through controlled agitation in his special process of blending. Get a bottle of *Rocking Chair*—and port your helm for solid enjoyment!



**MR. BOSTON**  
**ROCKING CHAIR**  
**BLENDED WHISKEY**

86 Proof • 75% Grain Neutral Spirits • Ben-Burk, Inc., Boston, Mass.





# High Ramparts

A Complete Full-Length Action Novel Featuring  
John Masters, the American Eagle

By LIEUT. SCOTT MORGAN

Author of "Convoy Blitz," "Wings of Treason," etc.

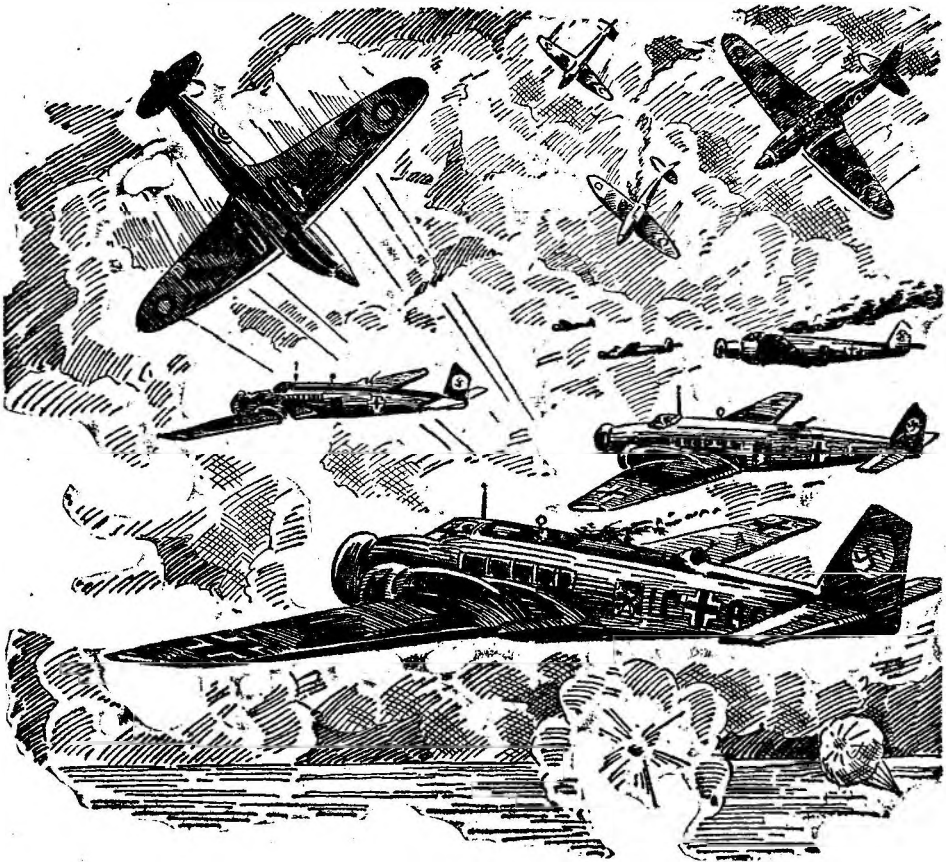

Masters tangled with the four-motored giant (Chap. X)

## CHAPTER I

### Night Watch

"CALLING Eagle Flight . . .  
Calling Eagle Flight . . .  
Can you get us, Eagle  
Flight? Come in."

"I hear you," John Masters said  
quietly.

The American Eagle banked and  
headed back toward the English coast.  
He gave the rheostat a quick twist to  
turn up the volume on the plane to  
ground frequency. He waited for the  
voice to break through the thin crust  
of static crackling in his phones.

"Come in," he said.

"Enemy formation approaching

---

# The Eagle Fights a One-Man War Against

---

coast from southeast at eighteen thousand," came the voice. "Apparently heading for M-Two-J-Four. . . . Repeat. Apparently heading for M-Two-J-Four. . . . Heather flight coming from south to intercept."

"Okay," Masters said. A light came into his blue eyes at the prospect of action.

"Eagle Flight . . . Eagle Flight! Just a moment." An excited note entered the voice of the officer talking from Sector Control. "The dough is in refrigeration."

"Good." Masters grinned, and his heart began to beat faster as he signed off and swung his two-engined Havoc toward the south. To him, that simple sentence didn't mean that somebody was making ice-box cookies. It meant that the American flag had moved closer to the arena of battle, was unfurling its red, white, and blue folds to throw the fear of God into the heart of the tyrant who sought to grind the world under his bloody heel.

Masters had expected the move, and had arranged for the simple code message to be flashed to him from Headquarters Fighter Command the minute it was confirmed. For "dough in refrigeration" meant that doughboys had landed in Iceland.

"Got to keep it from the Nazis until the boys are established up there," he muttered, as he settled his feet in the rudder.

The chatter of Heather Flight rushing pell-mell through the night to intercept the raiders reached his ears.

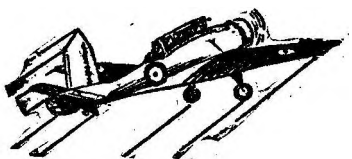

A grim smile played around his lips. But he was not thinking so much of the surprise the Huns were going to get when the flight of night-flying Havocs hit them as he was picturing the surprise of *Herr* Hitler when he learned that America had established bases in Iceland to keep the Atlantic sea lanes open.

**W**ITH throttles wide open he thundered toward the spot where he hoped to catch the Nazi craft winging through the moonlit night. To his right he could see the waving tentacles of the searchlights pushing silently through a gap in the overcast. Archie began to stipple the skies, adding their scintillating jewels to those already hung there by Nature.

"Enemy aircraft just behind us, sir," the rear gunner said over the intercom. "Appears to be heading northwest. Should judge it to be about two thousand feet below us. It's a Junkers."

A single aircraft winging through the heavens more than likely was a Nazi out on a reconnaissance, and consequently was of no particular importance, with a flock of egg-layers to the south.

For a moment or two Masters held his course. He scanned the skies anxiously, on the watch for possible convoying fighter planes sitting upstairs.

Suddenly a sickening thought flashed through his brain. The skin tightened along his firm jaw and his feet tensed on the rudder as he realized the truth. He had many times done the very same thing himself, when he had wanted to slip across enemy territory unnoticed, or perhaps drop in on them by chute for a visit. The enemy raid to the south was a

---

## John Masters Roars Over Iceland to

---



---

## a Death-Dealing New Secret Weapon!

---

blind! The single job behind him was the important ship.

Whirling quickly, he turned up the volume on the plane to ground frequency again.

"Eagle Flight!" he said crisply into his flap mike. "Eagle Flight! . . . Important! . . . Important!"

"Come in, Eagle Flight," the calm voice of the controller answered.

"Imperative I change plans at once," the Eagle said slowly. "Will report on my return. Can say no more now."

"Very well, Eagle Flight," the controller said.

He knew Masters, and the work he had done in the past. Whatever the Yankee said went with him. And besides, orders from Downing Street gave the American Eagle *carte blanche*.

Careening madly to intercept the single Nazi somewhere to the north, Masters leveled out at fourteen thousand. At that altitude he should be able to catch the silhouette of the enemy plane.

"Keep your eyes peeled, lads," he said over the inter-com to the man in the forward position, and the gunner to the rear. "This may be important."

"Righto, sir," came the quiet reply from the rear.

"Do you want him blasted out of the air in two big pieces, or a lot of them?" asked the gunner up front, chuckling.

"Neither," snapped Masters. "We'll try to drive him inland. Then we'll set him down and find out what he's after."

Masters was pouring the soup to the two big motors. And the American-built job was knifing the air at better than three hundred.

"Just off our starboard bow!" yelled



the gunner in the nose of the Havoc. "Not more than a thousand feet below us."

"I see him, Walters," Masters said, as he eased over and cut in behind the blur silhouetted against the expanse of moonlit overcast.

He held steady for a moment.

"You watching the sky back there, Herbert?" he asked.

"I am that, sir," the rear gunner replied. "Watching for a star to blot out."

"Good," said Masters. "When we close in, you fire around him, Walters. Keep your tracer just beyond his wings. Got to keep him heading west."

"Very well, sir," Walters' voice came from the plexiglas nose of the Havoc.

**M**ASTERS reached forward and tuned down to the frequency used by the Nazis. He heard only the crackle of static. He had hoped to

---

## Protect the Soldiers of the United States!

---

catch some words to indicate just who this strange pilot was, an "on course" signal or something to give him a clue to the Hun's destination.

Pulling the map into position, Masters traced the probable course of the big twin-engined job with his finger.

"Nothing up there in the north he should be interested in," he thought.

His finger trembled as it passed the northernmost tip of Scotland. The line he was drawing would take the German plane right on over the sea and straight to Iceland!

"No!" he yelled. "They couldn't! Can't be that one of their slinking Fifth Columnists has already tipped them off!"

Yet there it was. The enemy plane could not possibly be headed anywhere else but Iceland. And at that moment words began pouring out of his phones.

"Kurt! . . . Kurt! . . . *Achtung* . . . *Ein* . . . *Englischer flieger* . . . *Schnell*, *Kurt!*"

The words were echoed by the rattle of the guns behind him.

"Messerschmitts!" Herbert was yelling into the inter-com as he unleashed the vengeance of his guns. "Coming down on us from two sides! Must have been sitting high."

Masters realized the tables had been turned. While he had stalked the big Junkers, he in turn had been revealed by the overcast to a flock of escorting Huns.

The guns chattered on all sides as he swept into a tight turn, then reversed his course. He was trying to bring the Havoc in close to the ship just below him.

"Give it to him, Walters!" he ordered. "Never mind the wide shots. Pour it in!"

The big-caliber gun up front began to cough, throwing heavy slugs at the weaving Junkers.

"Herbert!" shouted Masters. "I'm going to bank. Swing your guns quickly and see if you can get in a burst."

Heeling into a half-roll, Masters turned over the Junkers, offering his gunner a perfect target. But he heard no shots.

"Herbert!" he yelled. "Are you all right?"

He struggled to evade the tangled skein of hot tracer pouring in on him.

"Herbert!" he yelled again.

"I stopped a proper packet, sir," came the weak answer over the inter-com. "I'm done in. Sorry I didn't nail the blighter. . . . Thumbs up, sir."

That was all. The voice died in a choking gurgle. Masters called again, flying automatically now, swinging from right to left in an effort to keep out of the snare of tracer, but got no answer.

He had only the man up front now. It was like flying a single-seater with a single gun in the nose. And all around him raged the ME 110s, each intent on battering a way clear for the Junkers.

"It's up to you, Walters," Masters said, coming out of a steep bank. "Herbert's through. Got to make every shot tell."

"It's them or us, sir," came the quiet response. "I'll do my part."

Masters heard the gun up front bark viciously. He saw a flash of flame at the wing-tip of the Junkers. The ship staggered, then righted itself.

"Nice shooting!" Masters shouted. "I'll try an' put you in position for another."

"Righto," Walters said. "I'll get him next time."

**I**T SEEMED an eternity before Masters was able to maneuver the Havoc close to the weaving Junkers. The Messerschmitt fighters blasted the night air to shreds with their guns, pouring converging lines of blazing tracer around the two-engined job.

Time after time the Eagle heard slugs pattering against his ship. Twice explosive slugs from the twin cannon guns in the nose of the Nazi



crates chewed great chunks out of his fuselage. Twice the wide-awake man up front let go with his gun and literally blasted a swastika plane out of the heavens. But each time the remaining Nazis bored in closer, pulling their flaming web of death tighter around the Havoc.

"Only got a few shells left, sir!" Walters shouted during a split-second lull in the battle. "I'll save 'em for the Junkers. Just get me behind him—that's all I'm asking."

Swinging through a trio of Messerschmitts, forcing them to give ground by his very daring, Masters managed to gain a position on the tail of the Nazi ship.

"Now!" he cried. "Give it to him!"

The gun cracked.

Masters was looking for the flash to tell him Walters' aim had been true when a hurricane of lead poured over the Havoc. The cockpit enclosure was shattered in half a dozen places.

"Fire!" Walters cried. "We're on fire!"

Masters saw it too. A sheet of flame burst into life along the port wing. It wouldn't be long now.

"Better scramble," Masters ordered. "I can keep her in the air for another minute or so by sideslipping."

"Sideslip then," Walters said. "We're getting that Hun. Quick! Give me a little more rudder if you can. He's right near us now."

Smoke boiled through the shattered cowling cover. The red glare of the flames lighted his ship from stem to stern. It was getting warm, much too warm. Even the Huns were easing off.

Masters heard the gun up front bark. He couldn't see whether the shell had struck home, because of the blinding smoke.

"That does it!" Walters cried. "Get him square in the stern. His blasted rudder's fairly spoiled."

"Then scramble!" shouted Masters, as he yanked at the catch and threw the panel open. "Be seeing you."

He pushed himself through the

opening, poised for a moment, then leaped into the flame-lighted night. Just below him he caught a quick glimpse of the Junkers about to spin through the overcast.

Reaching for the rip-cord he yanked, and waited for the crack overhead to tell him his chute had opened. When it came, and he looked up to see the silk billowing above him, he manipulated the shrouds to steady its wild gyrations. Then he looked for Walters, and saw that his gunner's chute was already open and on the way down.

"Okay, Walters?" Masters yelled over the hundred yards or so that separated them.

"Yes—" Walters began, then his voice was lost in the harsh clatter of a machine-gun. The upraised arm fell limp. The Englishman sagged in his harness.

"You filthy swine!" Masters roared at the Messerschmitt. "Even with us dropping in the Channel you have to bore us!"

**T**HE Messerschmitt swung toward him. Masters closed his mouth grimly, reached for the shroud cords and spilled the chute. With the fabric rattling above him he fell almost free until he hit the overcast. As the chute filled again he heard the roar of the Messerschmitt as it zoomed.

"The rat!" he snarled. "I'll get Walters' share for him."

He broke through. Below he could see nothing but a dark void. He waited tensely, his fingers glued to the safety box. Then when his feet touched the water he released the catch and slipped free. The water closed over him. He struck out for a moment, then came gasping to the surface, buoyed by his Mae West.

Blowing the water out of his mouth, he oriented himself by the sound of the MEs going home, then he began to paddle in the opposite direction. Off to the west was England, at least five miles off. The nearest land was

about four hundred feet away. But that was straight down, and he wasn't going that way just yet.

## CHAPTER II

### *Out of the Frying Pan—*



MASTERS had not taken more than a dozen strokes when a cry reached his ears. He stopped paddling, held his head above the chop to listen. "Ach, Himmel! Hilfe, hilfe!" The choking cry came from the left.

"One of the whining Nazis," Masters growled as he spat out a mouthful of cold sea water. "Minute things get a bit tough they start bellyaching."

He struck out again, but paused as the frantic yell reached him again. He hesitated, then turned toward the cry.

It took him about fifteen minutes to locate the man in the dark. Then as he approached the thrashing man, he forced himself a little higher in the water.

"Was ist?" he called in German.

"Bitte! Bitte! Lass ihm los!"

"Untie who?" the Eagle growled to himself.

As he cautiously approached the German, the wind split the overcast and the moon bored through to light the Channel with a silvery streak. He could see the man now, flailing frantically at something in the water.

"Was ist los?" the Eagle asked again, when he was close.

The slanting rays of the moon revealed a face contorted by fear. The German could only slobber now as he pointed to the thing bobbing against him.

Then Masters saw the difficulty. In bailing out, the German had dropped into the water, only to have the bullet-riddled body of Walters come down on top of him. Consequently the two chutes and their shrouds had tangled, trapping the Nazi like a herring in a gill net.

Masters set to work with his knife and cut the shrouds one by one. And as he worked he wondered who this Hun was. He dared not ask a direct question. But he had a hunch this man was the pilot of the Junkers. Walters had promised to get the Nazi, and it seemed even in death he was trying to keep his vow.

When the Eagle had freed the tangle, he pushed the body of the Englishman to one side, muttering a quick little prayer. He was not cold-blooded, but this was war. He had to be practical. Walters had paid the awful price, a price that might mean the saving of hundreds of lives—thousands. Yes, and perhaps the cause for which they were fighting.

"They murdered you, Walters," Masters breathed. "I'll make them pay. I'll put a few down on the score for you. Happy landings. Be seeing you."

He turned from the body. His eyes held the German's a moment. Then he took a stab in the dark and hit the target square.

"Los! Vorwärts, Kurt." He reached for the man's shoulder. "We go this way," he added, still speaking German.

"Danke schön," the German sputtered through the spray. "You are one of Ludwig's pilots, no? You must be. You know my name."

"Ja whol," Masters said. "Now save your breath. We have a hard road ahead of us."

In silence the two men paddled toward the west. Once the German questioned the choice of course, but Masters quickly cut him off by telling him that land was only a mile away in that direction.

"We land in England then!" sputtered the German. "No! No, I must not! We must turn back."

That was when real silence settled between the two. For the Eagle kicked himself half out of the water and lashed his doubled fist full on the chin of the Nazi.



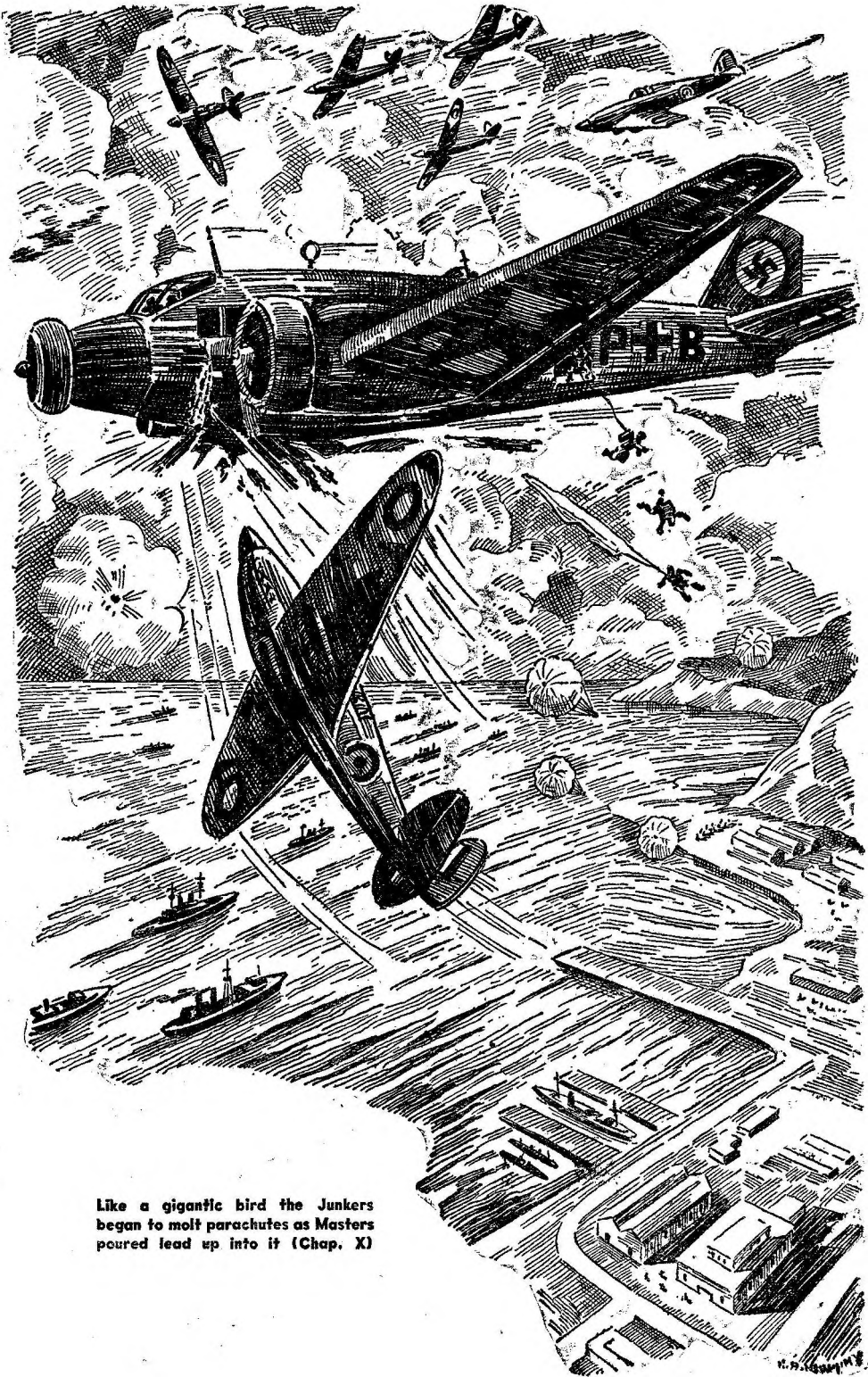

**Like a gigantic bird the Junkers began to molt parachutes as Masters poured lead up into it (Chap. X)**

"Now maybe you'll hold to the course," Masters sputtered. He reached out and grabbed the unconscious man's collar. "Pop off again an' I'll give you the works."

**A**S HE paddled over the crest of a wave, dragging the unconscious man behind him, Masters quick eyes caught sight of a blurred hulk riding the sea a scant hundred feet away. He stopped paddling and waited for the next wave to lift him.

The overcast was being broken up now. The clouds were bunched together like frightened sheep, and the wind herded them toward the east. The moonlit Channel was like a sea of molten metal.

Masters could not quite make up his mind whether to approach the shadowy thing before him, or to skirt it entirely.

"Might be one of their darned E-boats snooping around," he told himself. "Yet it doesn't quite have the lines. Sits lower in the water."

At last he decided to have a closer look. But he had to stop a moment. The Nazi was coming to.

"Quiet!" Masters cautioned.

"Don't hit me again!" the German pleaded.

"Yellow," Masters sneered. "Every one of you. Put you in a pack, and you're like a bunch of wolves. But alone you're sheep."

Keeping a grip on the man, Masters moved silently through the water. When he got closer, a grin spread across his face. For he recognized the craft as one of the rescue pontoons the British and Germans alike anchored in the Channel to save airmen who fell into the sea.

As he reached the ladder hanging over the side, the German slipped from his grasp. Before he could catch the man again a wave smashed the Nazi against the steel side of the float. He heard the fellow's head hit the plates with a dull thud.

"Hey, you!" he cried. "Don't try to

wreck this thing. I'm tired of swimming."

His hands found the German's collar. The chap was out cold again, and the light of the moon showed an ugly cut by the side of his temple.

Clinging to the Hun's arm, Masters wormed himself up on the deck and pulled the man after him. Laying his captive on the plates he looked around. From the markings, this was a Nazi float.

**M**ASTERS shrugged and smiled grimly.

"Any old port in a storm," he muttered, as he opened the door in what looked for all the world like a miniature conning tower.

He found the steps and went below. It was pitch-dark down there.

Fishing in the pockets of his sodden clothes he found what he wanted and laid it on the floor. Then, drying his hands, he set to work. In a few moments he struck a match. On the floor lay a metal tube such as that used for tooth paste. By its side lay a lump of white. Masters had learned that trick in the north woods—melted wax poured over matches placed in a well cleaned collapsible tube. When he wanted them, all he had to do was tear the soft metal of the tube, pick a match free of its bed of wax and strike it.

Lighting a lamp hanging over a small metal cabinet, Masters gave the little compartment a quick once-over, then went up the ladder and brought down the German.

The Nazi babbled incoherently as Masters patched up the cut.

"If I could only get him talking straight," the Eagle thought, as he pressed a strip of adhesive tape to the wound.

He studied the contents of the first-aid cabinet. Enough bandage and material there to take care of a *Staffel*. A plan flashed into his mind.

Working swiftly he poured the German out of the wet flying suit.



As he lowered the man back to the floor he whistled sharply when his eyes caught the flash of metal under the Nazi's tunic. Quickly unbuttoning the coat, Masters was surprised to find a large metal flask, shaped to fit the pilot's body. It was held tight by shiny metallic bands passing around his chest. Finding the catch to the straps, Masters took it off and then unscrewed the cap. A sweet, cloying odor filled his nostrils.

"Boy, what a perfume bottle!" he thought, as he put the cap on again and placed the flask on top of the cabinet. "Got to get him talking now."

Slashing the tunic away, and then the sodden undershirt, Masters ripped the metal screw cap from a box of salve, bent it to form two jagged points and placed it on the Hun's chest close to his heart. Then picking up a roll of gauze he proceeded to wrap yards of bandage tightly around the Hun's heaving torso.

Next, he went to work on a leg. Rolling the tube in which he had carried the matches into a rough wad, he placed it against the flesh, and again wound bandage around it to hold it tight.

"Now, Fritz," he muttered, grinning, "you hustle yourself out of it."

While he waited for the man to come to he picked up the rag with which he had wiped the wound free of blood and smeared it over the gauze he had wrapped around the Hun's chest. When he was through the Hun looked to be a gory mess.

Searching through the cabinet, Masters discovered a bottle of brandy. He poured a good swig, held it to the man's lips and let it trickle between his teeth. The Hun gasped, struggled in Masters' arms, and finally opened his eyes.

"Where am I?" he gasped. His face was suddenly contorted by a twinge of pain. "*Ach, Gott!*" he moaned. "I am dying. *Der Englischer flieger* hit me . . . Is it bad?" His eyes narrowed as he looked up at the Eagle.

Masters finished getting into the flying suit he had taken from the Nazi, then knelt by his side.

"Through here," he murmured, tapping his fingers against the German's chest. "Does it hurt much, Kurt?"

The German pilot squirmed and pressed his hand against his chest.

"It is awful! It feels as if a knife is being pushed into my heart."

"Here, Kurt." Masters held another drink of brandy toward the Hun who was looking down at the blood-stained bandages on his chest. "I did the best I could, Kurt, but I am no doctor. Here."

Kurt swallowed, then choked as the liquor caught at his throat. The movement pressed the points of the screw caps harder against his skin.

"It is awful," he moaned. "Get me to a doctor! *Bitte!*"

**S**UDDENLY the man started. His hands flew over the bandages on his chest.

"The flask!" he cried. "The flask of dutranamide! Quick—where is it?"

"Take it easy, Kurt," Masters said, as he pushed the man back. "You must not. You will start the blood again."

"But the flask! It must not be lost."

The man's eyes were wild as Masters held him down with one hand and poured a drink with the other.

"*Ach, my leg!*" exclaimed the man. "Is it broken? It must be! I can feel the bone sticking right through my flesh."

"Here, drink some more," ordered Masters. "I've got to keep you alive until the doctor comes. Sip it this time."

But the man gulped it down and relaxed in the Eagle's arms, but only for a moment.

"The flask!" he cried again. "M-Eleven needs it badly." The man's eyes were shining now as the liquor began to have its effect. "He needs it! The other plane was shot down. You know the cursed Americans must be taught a lesson."

**M**ASTERS' fingers tightened on the man's arm, but relaxed quickly. He dare not seem too anxious now.

"You must be quiet," he ordered. "That wound in your chest is bad."

"But the flask!" babbled the Hun.

"I had to take it off to dress your wound," said Masters. "The bullet slid behind it and entered your chest." He moved his hand down the man's arm and felt for his wrist.

"How is my heart?" demanded the Nazi. "If it was not for this awful pain in my chest I think I feel better."

But Masters was not feeling the pulse. His eyes were glued to a silver identification tag fastened to the German's wrist by a thin chain. His fingers worked deftly. He slipped it off and dropped it in his pocket.

"Kurt von Gelsen," he murmured. "Von Gelsen . . . I wonder."

He held out another drink. "Here, I think you are getting stronger. You will be with the *Herr* Professor, your father, soon."

"You know then?" demanded the startled Nazi.

"Of course," Masters said quietly. The brandy was doing its work. "But I did not know he was the famous M-Eleven."

The Nazi brushed his hand across his mouth. He shook his head slowly.

"But he is not M-Eleven. M-Eleven is there."

"Where?" demanded Masters.

Suspicion clouded the now drunken man's eyes.

"They told me not to talk," he mumbled. "But you are one of us, are you not? You know we must drive them out. . . . What did you do with the flask?"

Masters pointed toward the cabinet. "You see, I knew. I took care of it. I am to carry it on to M-Eleven as quickly as possible."

The Nazi snickered maudlinly, and a silly grin crossed his face.

"But how will you know where to find him?" he taunted. "Only Hans

and I knew. Hans had three flasks when he was shot down over the North Sea. M-Eleven needs more, but this was all my father had." The Nazi began to laugh. He reached for another drink. "Poor Papa. He does not know. He thinks the dutranamide is being used to—" He stopped. His eyes began to flutter shut.

Masters shook him. "Come on, Kurt. That is not polite."

"Only M-Eleven knows the combination," Kurt murmured sleepily. His eyes opened. Fear crept into them. "Am I dying?"

Masters nodded. "Tell me quick! I must get the flask to M-Eleven. Where can I find him?"

"First you must find—" The man stopped and his head rolled weakly.

"Over-estimated his capacity," thought the Eagle, with an inward curse. He laid the man's head on the floor. "Now I have to get him out of it and start all over again."

Straightening, he glanced down at the Hun. A grim smile played across his face.

"You're gonna be awful sore, mentally not physically, when you get those bandages off, Kurt, old man."

He stepped across the Nazi and picked up the flask.

"Must hold about two—"

He stopped muttering. His eyes narrowed. He cocked his head and listened. His ears caught the low throb of a motor. It came out of the east.

Putting the flask back on the cabinet he made a dash for the iron steps and reached the deck in time to see a low, sleek-looking power boat cut the waves and slide up to the float. A shielded beam flashed on and caught him in its ray.

"*Guten abend*," Masters said calmly as an officer leaped to the tiny deck. "We have been waiting for you."

"You are *Oberleutnant* von Gelsen?" asked the German. "You wirelessed that you were going down?"

"No," Masters said. His mind raced as he tried to figure some way to es-



cape the trap. "Von Gelsen is below. I think he is dying. Come—we must hurry."

Then, instead of making a break for freedom, the Eagle calmly led the officer below, deeper in the trap into which an unkind fate had thrown the Yankee air ace.

who held a grim secret in his alcohol-befuddled brain.

"We must get him ashore at once," Masters said.

The drunken Nazi moved. A groan came from his lips as he pawed at his chest.

"I will get one of the others to help

*Featured in the Winter Issue of Our Companion  
Air Action Magazine*

## RAF ACES

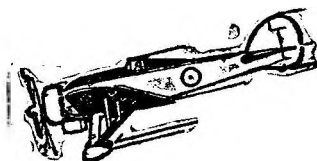

## BRITISH WINGS

*A Full-Length Exciting Sky Novel*

**By ROBERT SIDNEY BOWEN**

Plus Many Other Stories and Features Glorifying the  
British Pilots Fighting for Democracy

EVERY AMERICAN MUST READ

## RAF ACES

NOW ON SALE 10¢ AT ALL STANDS

**D**OWN in the narrow compartment, Masters turned and faced the officer, depending entirely on the Nazi flying suit he wore and his knowledge of the German language to bear him out in his masquerade. Between them lay the unconscious man

us get him up," Masters said slowly, while the officer bent over the figure on the floor.

"This man is drunk," snapped the officer. There was suspicion in his eyes as he looked up at Masters.

"I had to fill him with brandy to

deaden the pain while I set his leg," said Masters. He moved closer to the ladder. "He asked me to see that this reached shore safely."

He held the flask out in full view, then turned and hurried toward the deck. As the Eagle hit the top rung the officer was after him.

"Give me that flask!" he shouted. "They told me on shore to see to it myself. It is important."

"You're darned right it's important!" cried Masters. He lashed out with his foot and caught the surprised officer in the face.

As he tumbled out on deck a bullet whistled past his ears. He stumbled, and bumped into one of the men from the E-boat. Acting quickly he swung the flask and caught the man behind the ear. The man slipped to the wet deck just as another shot spewed from the little conning tower.

"*Schnell—schnell!*" shouted Masters.

He was in the boat now, flailing away at the man holding the boat hook. One, two, three—the fourth blow sent the man staggering. He clutched at Masters, missed and fell over the side with a splash.

Throwing the flask on the engine hatch, Masters slid the gears in mesh, kicked the throttle open, and roared away from the floating refuge.

And only then did he become conscious of the sound of airplane motors in the sky overhead.

Wondering why the officer on the float was not shooting Masters glanced over his shoulder in time to see a winking light. It was pointed toward the heavens, pouring a message into the night. And when he looked up he saw a light flashing a reply from up there.

A second later a flare hissed through the night and bloomed into a white searing light.

"Out of the frying pan into the fire," he muttered and began to zigzag in anticipation of the slugs he knew would soon rain down on him.

## CHAPTER III

### *Double Danger*



**D**RIVING the boat at full throttle, and swinging the wheel from right to left, Masters managed to avoid the first terrific burst of fire from the planes above. As it was, the slugs were too close,

lashing the water around him into a froth of small geysers.

Keeping his eyes shielded from the glare of the light drifting out of the heavens, Masters caught a glimpse of a Hun airship as it zoomed ahead of him.

"More Messerschmitts," he growled.

Behind him he heard the roar of a pair of 1,150 Daimler-Benz engines. Bracing himself, he threw the wheel over. The boat swerved and threw a fan of spray as it came around. The hurtling Nazi missed him by twenty-five yards and was forced to zoom away to let another crate have a shot.

Now the ME 110s were swarming on him. Their motors filled his ears with a deep vibrant droning. The air snapped and crackled around him as the Huns let go with their cannon guns. The big slugs kicked up a fearful spray as they exploded around him. Twice the explosive things caught his boat, and tiny chunks of metal whined around his head.

But even while he fought for his life the Eagle's mind was occupied with this new mystery so suddenly tossed in his face. That the occupation of Iceland was no secret he now knew full well. Even now plans were being laid to spring some foul scheme on the Americans based up there on the bleak island.

"Wonder what this dutranamide is?" he muttered as he kept changing the boat's course. "More important, what's it for? What's all this M-Eleven has up his sleeve?"

A crashing burst from the rear gunner of one of the ME 110s drove



everything else from his mind. For a second it was nip and tuck whether he would be able to avoid the slugs slashing at him over the water. He heard a couple of the missiles chunk into the planking. Another of the larger shells from the forward guns hit the stern of the dodging boat, sending a shower of splinters and metal around him.

Back and forth, sometimes running in tight circles, Masters used every trick at his command to forestall the doom pouring down on him out of the moonlit heavens. The Jerry flyers were coming at him in relays now. The air was always full of the blazing tracer.

"If they hit the tanks I'm through," he told himself grimly, as a Messerschmitt thundered over him.

Another flare hissed into life. The Channel was always lit up, it seemed. There were no cool shadows in which to hide from the flaming holocaust dropping around him.

He glanced over his shoulder at the little cabin.

"I wonder," he said aloud, as the boat roared through a curtain of fire. "Must have."

Letting go of the wheel, and giving the bucking boat free rein, Masters hurried back to the shelter, and in the dim light below he saw what he wanted.

It took only a second to reach the little panel of the short-wave ship-to-shore phone. His eager fingers found the switch. He began to turn the dial while waiting impatiently for the tubes to warm up.

But they didn't get hot. There was not a single glow from the grid. And when he looked behind the panel he saw why. One of the heavy caliber slugs had bored through the roof, exploded and sent fragments battering through the wiring. The thing back there was a mess, useless.

Bitter with disappointment, the Eagle stumbled back up to the heaving deck. The uncontrolled boat was weaving in all directions. Now and

then a sea caught it broadside and sent a hill of water cascading over the side.

Masters shook his fist at the Huns, then made a grab for the wheel, sending the craft off on another course just as an ME unleashed a vicious burst of fire.

As the bullets slashed the air, Masters' ears caught the sound of a dull boom. A second later a flaming torch plummeted through the heavens and crashed into the sea about a quarter of a mile away.

Now there seemed to be more machine-guns than ever. The sky overhead was filled with screaming wings. The air was torn to shreds by whirling props and the roar of motors.

**A**T THE edge of a circle of light thrown by a drifting flare, Masters caught sight of a pair of green wings. A shout poured from his salt-crusted lips. For, flashing in the light were the cocards of the R.A.F!

"Give it to them!" he yelled, as he saw a stub-nosed Havoc pour into a Messerschmitt and send it hurtling toward the eager, reaching waves of the Channel. "Drive 'em off! I've got to reach shore."

The battle raged in earnest up there now. The Nazis were forced to abandon their attack on the E-boat to protect their own skins. Guns rattled in the night. Now and then a flaming thing like a meteor run amok curved through the sky, smashed into the sea, leaving nothing but a cloud of steam to mark its watery grave.

Twice, a British Havoc cut in low, and the rear gunner plastered the Eagle with crackling tracer. But the flares had died away, and all they could see down there was a dark spot, and a zigzagging wake. They could not see his frantic signals for them to keep away. Nor could they by any stretch of the imagination hear him shouting. But he shouted just the same.

Bit by bit the R.A.F. boys drove the

Messerschmitts east, back toward the foul lair from which they had sprung into the night. Bit by bit the Eagle was able to straighten his course. He could hear the battle dying away behind him like fading summer thunder.

Then without a second's warning a ship came screaming out of the stars. A flare popped and once again the water was lit like day. A twin line of tracer curved around him, grabbing at the speeding boat, hitting the water sometimes, to throw a mass of spume across his bow.

"Now what?" Masters thundered as he braced himself and threw the wheel over.

Slugs thundered along the hull when the craft came around. He heard the planking splinter, the crash of metal against metal. His nostrils quivered as they inhaled the burned powder.

A flare of flame burst into the night to vie with the searing glare of the magnesium torch floating down from above. Masters glanced over his shoulder, expecting to see the plane tumbling into the sea. But instead his horrified eyes met a sight that caused the blood to run cold in his veins. The craft he was driving through the Channel was ablaze!

A sheet of flame, ignited when an explosive bullet had hit the fuel tank, fanned across the stern of the boat, leaving a curling wake of acrid black smoke to smother the foaming wake.

Gritting his teeth, Masters shot the throttle home, determined to be as close to the shores of England as possible before the craft settled. He had to risk the possibility of an explosion that would blow her into flaming fragments. No risk was too great now. Not with the Nazis planning some dastardly thing against the Americans who were trying to keep Britain's lifeline open. Not with this M-11 lurking somewhere along those grim lava-knifed shores.

With the flame scorching his back he drove steadily west, every muscle

tensed, waiting for the moment to jump. He was thankful now that he had kept on his Mae West under the flying suit he had taken from the Hun.

Despite his precarious position, a grim smile tightened the determined lines of his face when he thought of the man, Kurt, back on the rescue float.

"Poor Kurt!" He grinned. "Wonder if he's still breathing his last? More than likely he'll faint in earnest when he sees his 'wound'."

A hail brought him back to grim reality. A burst of machine-gun fire spurted across his bow. Then a light leaped into existence and caught at his boat.

"Heave to, you bloody Hun!" a voice roared out of the night. "Wot you think you're doing—settin' fire to the ruddy Channel."

Masters' hand hit the throttle. It was then he realized that he had heard the command only because the powerful motor had just quit.

"Hold off!" he cried. "I'll jump and swim for it. This tub is going to explode."

"Be quick then!" ordered the Britisher. "First thing you know we'll have a flock of your Nazi snoopers around to see wot's blazing."

Masters started for the hatch. He stopped and grabbed for the gunwale. A curse of frustration exploded from his lips. For there, white-hot in the middle of the flame, lay the metal flask! He stared at it a moment then as the skin began to prickle along the back of his neck he leaped over the side.

Once again the old warning had stood him in good stead. For as he came spluttering to the surface, the middle of the blazing craft was enveloped in a sheet of weird green flame. It mounted toward the sky, casting a sickening glow over the heaving waters. Then, as it died, the main fuel tank let go. The speedboat in which he had been flying to friendly





The air crackled around Masters as the Huns let go with their guns (Chap. III)

shores disintegrated in a thousand whirling fragments of flame.

Masters forced himself under and waited for the stuff to stop falling. He could hear it chunking around him, and prayed the motor would not find a resting place on top of his skull.

At last he came to the surface, gasping for air. The buoyancy of his life-belt had made staying under a battle that had taxed his strength to the limit.

"Where are you?" he managed to gasp.

"Right here, you blasted Nazi!" growled the voice of a shadowy figure, as the trim lines of a British patrol boat slid out of the night. "Took time to signal, even while we were tryin'

to help you, didn't you? Half a mind to bash you one."

"But I'm no Nazi," Masters exclaimed as he spat out a mouthful of salt water. "I'm an American. Name is Masters—John Masters. I'm the American Eagle. You've heard of me, haven't you?"

"Sure, matey," replied the Britisher, helping him to his feet. "I've heard of Napoleon, too. We pick up all kinds of things out here."

"But I am the Eagle," Masters persisted. "Call a shore station and get them to contact HQ, Coastal Command. It's important. They know that the Americans are in Iceland."

"Take it easy, Fritz." The British commander of the patrol boat grinned.

"In the first place we aren't contacting shore stations. Your pals have got wireless outfits, and are just waiting for us to give our position away. And that business about Yanks being in Iceland is just a lot of well boiled haggis."

**M**ASTERS reached for the man, but as quickly drew his hand back.

"Listen!" he said. "You're going to be a pretty mess if you don't get me ashore at once. There's some plan afoot against the Americans in Iceland. I've got to contact Mr. Churchill at once."

"I suppose you want to see if he's got your invitation to have high tea with the king an' queen?" sneered the Britisher. "If there's any devilment afoot up there our own lads can handle it without your help. So pipe down. We'll have you ashore fast enough. But first we're going to have a look at our little fish trap out here. See if we bagged any more of you slimey Nazi eels."

"You mean the float, off to the northeast?" demanded Masters.

"You know it?" the Britisher asked cautiously.

"I was on it a few minutes ago," snapped Masters. "Escaped when the Jerries came up in an E-boat."

"A likely tale," growled the seaman. He turned and gave an order to the man at the helm.

"Listen!" Masters stepped close to the man. "If you find a Jerry pilot out there, and a couple of E-boat men, will you believe me? Especially if I tell you the Nazi pilot thinks he's dying, when there isn't a thing the matter with him."

"You'll have to explain that," declared the Britisher with a broadening grin. "I'm a little thick, and a bit unconcerned about the way Huns feel. Now say that again."

"You're correct about the thick part," Masters said quickly. "But maybe when you see this Hun I de-

scribe you'll realize I'm telling the truth."

"Tell me your tale," said the Englishman. "I've nought else to do but listen."

Then Masters explained what he had done to the pilot Kurt.

"And that green flare of flame was the stuff exploding," he concluded. "It wasn't a signal. It's something to do with this Hun M-Eleven."

"We'll see," muttered the skipper of the patrol boat. "She's just off there. Let's get moving."

In only minutes more the Eagle set foot on the steel deck of the rescue float, for the second time that night. The German officer and his men were quickly disarmed and taken on board the patrol boat while Masters and the skipper went below.

"You have come with the doctor?" Kurt gasped weakly. "I—I cannot last much longer. It feels like knives in my chest."

"We'll fix that by a slight operation."

Masters grinned as he knelt by the side of the German and cut the blood-smeared bandages. As the bandages fell away the German closed his eyes.

"I cannot bear to look," he moaned.

"Look." Masters laughed. "Do you good. You'll feel better."

The German raised his head slightly and looked at his chest. His eyes opened in amazement when he saw the twisted cover of the salve jar and the marks on his flesh where the two points had pressed hard. In a moment Masters cut the leg bandages and the wad of metal tube fell to the floor.

"Bet that sobers you completely?" the Eagle said, and grinned.

"It is a trick!" cried the German. He struck out at the Eagle but was still too drunk to drive his fist home. "You have tricked me! . . . Where is the du-tranamide? Where is the flask?"

"Safe enough, Kurt," said Masters, hauling the still intoxicated Nazi to his feet. He turned to the grinning Britisher. "Now what do you think?"

"I think I'd better get you ashore, sir," the patrol boat commander said quietly. "No stupid Heinie would ever think of a trick like that. We'll take him along, too."

The German tried his leg to make sure it was not broken. He glanced at his chest. His face paled with hate as he turned on the Eagle.

"Then it was not a dream!" he barked, almost frothing at the mouth.

"What?" Masters asked.

"About being trapped with a dead man out there," rasped the Nazi. "I thought it was a dream brought on by the wound. You hit me, too, did you not?"

"What's this about a dead man?" asked the puzzled skipper.

"Walters—my forward gunner," Masters explained. "They drilled him when he was coming down in his chute. He managed to fall on top of this one and gave him his first scare of the evening."

"Did you say Walters?" the skipper asked quickly.

"Yes. Sergeant Tipsom Walters. Know him? Stout gunner."

"He was my son." The Britisher bit his lip. "I'm afraid I've made an awful blunder. To think the swine got him at last!"

Masters reached out and touched the man's shoulder.

"He kept to his job to the last," he said softly. "With Englishmen like him Hitler will never win."

## CHAPTER IV

### *On the Trail*



PRIME Minister Winston Churchill chewed his cigar savagely and studied the American Eagle's face.

"So the blighters know about your President sending troops to Iceland," he muttered. He was worried and a slight trace of a lisp crept into his voice.

"Looks that way," Masters said. "Means I've got a job on my hands."

"But what is the connection between this Professor von Gelsen and the one you call M-Eleven?" asked the Prime Minister.

Masters shrugged. "Frankly I don't know. I do know that von Gelsen is one of the best chemists they have over there. Doesn't fit in with the present Nazi regime at all."

"But his son does?" interposed Churchill.

"As is so often the case," Masters said slowly. "Father against son is nothing new with the Nazis. It's the younger generation who have been trained since birth to be sadists. The professor, by the way, spent some time in a concentration camp. They finally released him and gave him a laboratory."

"What is his specialty?"

"Anesthetics."

"Do you have any ideas about this dutranamide?"

"Highly volatile, judging from the green flame it sent up," Masters said slowly. "It burns me up that I had it right in my hands—and lost it. Might have been able to make an analysis and be further along than we are."

Churchill shook his head soberly.

"Our own men have been getting the muddy end of the stick ever since Dunkirk," he said. "But I'd hate to see anything happen to your troops in Iceland. I know there'd be a fearful row raised by your so-called isolationists back home. Besides, many of your troops sent to Iceland are draftees. Make a horrible muck of things if they were the victims of some dastardly trick."

"I'll stop it!" Masters declared, leaping to his feet. "I've stopped the Jerries before. I can do it again."

"Have you checked with Intelligence about this M-Eleven, or about the dutranamide?" Churchill asked.

"I've gone through the files and covered the M-Eleven angle," Masters said. "Couldn't find a thing."



The phone tinkled. The Prime Minister picked it up, spoke through the corner of his mouth, then pushed it across the desk.

"For you," he said. "Hope it's good news."

Masters talked for a moment, then hung up. He slumped into a chair and ran his fingers through his hair.

"That was Warren," he said. "He has been over to the Chemical Division. He drew a blank too."

Warren—Phil Warren. The man who had been John Masters' friend since the days of another war when they had battled the Hun menace together, the companion who was always near him now, closer to him than any man in the world, and more trusted.

"What next?" The Prime Minister seemed eager for the suggestion of this American Eagle he held in such high esteem.

"Iceland," Masters said, glancing at the map on the wall. "I'm going up there and find M-Eleven."

"You know," Churchill broke in, "I've been thinking about this chemical and the weird green flame. Could it be something this M-Eleven expects to use in sabotage work?"

"Been working on that angle myself," Masters said, after a moment. "Sometimes a chemist, working on a drug, thinking he will aid humanity, stumbles over something pretty dreadful. But until we get a report from your agents in Iceland we can't tell."

"You think M-Eleven may have some of this dutranamide up there now?" Churchill pressed.

"One thing makes me think he has," Masters said. "This fellow Kurt von Gelsen made a single statement which leads me to believe M-Eleven is already at work."

"What was that?" The Prime Minister leaned tensely forward.

"He said M-Eleven 'needed more.' One plane carrying the stuff seems to have been shot down." Masters paused and picked up an Air Ministry re-

port. "Must have been this single Junkers that was shot down west of the Orkneys on the twenty-second. This fellow Kurt seems to have been answering a hurry call. Evidently M-Eleven has already been using dutranamide."

AS MASTERS finished speaking there was a knock on the door, and at the Prime Minister's curt command to enter a confidential secretary stepped into the room and laid a sheet of paper on the desk.

"I had it decoded, sir, the moment it arrived by wireless," the secretary said, and left the room.

Churchill slouched in his chair, read the few lines, then slid the paper across to the Eagle.

"There you are, Masters," he said quietly. "Everything seems to be quiet and under control up there. I asked Intelligence to contact the men in Iceland the minute you reported."

Masters glanced at the typewritten words and leaped to his feet again.

"That means he hasn't gone into action yet," he said promptly. "We may still have time. I'll leave at once. Warren will be along in a few minutes."

"Anything I can do to facilitate matters?" asked Churchill.

"Yes," Masters said. He stopped and looked down at the squat figure of the man who carried the destiny of England on his shoulders. "Let me have a look at this Kurt von Gelsen again."

"More questions?" The Prime Minister smiled. "After that trick you played on him he isn't very talkative. Can't say I blame him. Must be terrible to think you are dying and then find out you're only suffering from the lid of a salve jar."

Churchill pressed a button on his desk. He gave an order and turned back to the Eagle.

"You may see him any time," he said.

Masters nodded. "Now, another

thing," he suggested. "Can you manage to spread a report to the effect that one *Leutnant* Kurt von Gelsen made a daring escape from a British patrol boat that picked him up in the Channel last night?"

"Very easily, and thoroughly." Churchill smiled confidently. "I'll see that word gets to the proper channels."

"You might add that you think he managed to steal a fishing vessel," the American Eagle added, "and that when last seen he was heading toward Pentland Firth. And sometime this evening let slip that a seaplane has been stolen from the Kirkwall base."

"Righto," Churchill said, as he scribbled Masters' suggestions on a pad. "I'll see to it. Anything else? You're to have all the help we can give you, you know."

Masters shook his head. "I'll have a short talk with this Nazi, Kurt, then Warren and I will be off for Iceland."

Churchill pushed himself to his feet like a weary man. He reached a pudgy fist for the Eagle's hand.

"I've said this before, Masters," he said earnestly, "but I'll say it again. Good luck. Take care of yourself, for we need you in this fight against the madman in Berlin."

"I'll do that," Masters grinned. "But beating that fellow comes ahead of all thoughts of personal safety."

"There are a lot of your countrymen depending on you now," the Prime Minister said soberly. "With

a few exceptions, you Americans have all been helping us. Now you're helping America—not only America, but the world. With you on our side, we'll beat the madman. . . . Good luck. God bless you."

\* \* \* \* \*

**T**HE Eagle sat in the high semi-open cockpit of a Vickers "Wellesley" bomber and warmed the single Bristol Pegasus XX motor while Phil Warren checked the stowing of their gear.

The long, tapered wings trembled under the thunderous impact of the driving pistons. The three-bladed prop swished through the misty night air as Masters watched the dull glow of the instruments. The temperature needle crept slowly up the dial.

"Everything's all set, John," Warren finally said. "Kinda early, though, to be shoving off, isn't it? We'll get there before dawn."

Masters smiled. "No dawn up there this time of the year," he said over his shoulder.

"Gosh!" exclaimed Warren. "Forgot all about that. Say, if it's daylight twenty-four hours of the day when does a fellow sleep? Kinda interferes with his eating, doesn't it?"

"Nothing will interfere with either your sleeping or eating, Phil—especially your eating," Masters said.

Warren grumbled something under his breath.

"Now what?" demanded the Eagle, checking the instruments and fuel gauges.

[Turn page]

## READ OUR COMPANION ACTION MAGAZINE

FEATURING FIGHTING DAREDEVILS OF  
TODAY'S WAR

*In the Winter Issue*  
**CAPTAIN DANGER OVER LONDON**

*A Complete Book-Length Novel  
Starring the Daredevil Ace of Aces*

**By Lieut. SCOTT MORGAN**

Plus other stories and Features

**AIR WAR**

NOW ON SALE 10c EVERYWHERE

"Beats me how you manage to interfere with me," growled Warren. "I had a swell date tonight. And now you haul me off to Iceland where I'll see nothing but a lot of greasy Eskimos. Suppose you're looking forward to another mess of pickled birds."

Masters swallowed. He never had quite got over the feast he had been given in Greenland just a month or so before when he had been on the trail of *Der Rote Schneehuhn*. The taste of those little birds stuffed into a sealskin to pickle in their own oil had lingered with him, spoiling many a meal.

"Why can't these blasted Nazis pick some civilized country for their dirty work?" Warren growled. "Ten shillings wasted, too."

"What about ten shillings?" asked Masters, as he adjusted his chute harness.

"I just bought a new alarm clock," snapped Warren. "Now you tell me it's daylight all the time."

"But wait until you see the girls," Masters told him, grinning. "Best looking in the world, I'm told."

"I'll bet," sneered Warren. "Just can't wait to see one. Say, let's chase Huns in Paris some time. Good eats—at least they say there is, if you have the dough to pay for it—and the nice dames are still there, they say."

"Okay, okay," Masters said. "Get back there."

Warren started toward the rear, then paused. "That's one break I'm getting, anyway."

"What now?" demanded Masters.

"I got guns back there," Warren said. "Remember that dirty trick you played on me before? Took me up in a Fulmar an' I had to sit there an' take it without being able to shoot back. . . . Well, let's get it over with. Maybe my date will hold over until I get back. Swell chance, though, with these R.A.F. boys an' their pretty blue uniforms. You know, I'm beginning

to believe those R.A.F. guys are a nuisance."

With a final grouse, Warren went to the rear observer's office, fastened his chute, and gave Masters the nod that he was ready.

The Eagle poured the soup to the Bristol. Flares lighted the runway and went out the minute his trucks left the sod. He held her steady a moment, listened to the note of the motor, then swung into an easy, climbing turn.

**C**Rossing Tarbat Ness, he checked his compass and headed northwest across Dornoch Firth. The moors of Sutherland Country slid under his wings. Ahead of him lay the moonlit expanse of the North Atlantic.

It seemed no time at all before he was cutting between North Barra and North Rona, those two lonely sentinels of the sea. Here he again checked his compass bearing, and bore toward the distant horizon behind which lay Iceland.

Six hours later he sighted the snow-clad volcanoes jutting out of the tumbled terrain. The snowy plateau of Vatnajokull stretched back from the rocky shore-line. Behind it lay the towering peak of Askja, a volcano that held destruction in temporary leash below its ice-crowned cone. West of Vatnajokull lay the ice fields of Eyjafjallajokull, and further inland Hekla pushed her cone of ice at the clouds.

Skirting the southwest shore, Masters looked down on a sand-storm that was being driven before the wind like a yellow mist. To the left he could see the angry cliffs of the Westman Islands, where millions of auks and puffins came each summer to nest in the folds of the lava.

Changing course over the peninsula Masters approached Reykjavik at six hundred feet, then throttled down to circle the little northern city.

As they came in over the town War-



ren let out a yelp over the inter-com.

"What's the matter?" he demanded. "Off your course?"

"No," Masters called back. "Why?"

"You must be," Warren insisted. "This looks like some town in the north of Scotland. No igloos down there. Better land and find out where we are."

"We'll land out on the Thingvellir plains," Masters said loftily.

"The which?" barked Warren.

Masters shook his head and went into a glide. Ahead of him he saw the little flying field the R.A.F. had smoothed out of jumbled lava.

"Here we are," he said. "Welcome to Iceland!"

"Somebody's screwy," growled Warren as he leaped to the ground beside Masters. "Greenland's all ice. Iceland only has snow on top of the mountains. The rest is green. Hey, John, look! Is that a native? Now don't kid me?"

Masters saw the woman who was leading a scraggy-looking pony down the flinty road bordering the field. She wore the usual small round black cap, and dangling over her shoulder from the cap was a long silken tassel ornamented with a gold band. Over her full black skirt was an apron of silk, gayly colored. Her crowning glory was her hair, jet black, a black that matched her eyes. Her skin was clear as the crystal air swirling around them.

"That," said Masters slowly, "is an Iceland woman in native costume. Believe it or not, the women of Iceland are among the most beautiful in the world."

"For the first time since we started on this jaunt we agree," murmured Warren. "How about the grub? That the best in the world too?"

Masters had anticipated the question. He didn't stop to hear it. He hurried toward the Operations Office. His quest for M-11 was already under way.

His eyes lighted as he caught sight

of the familiar uniform of an American soldier.

"They're here," he murmured. "And here they'll stay. No devilish Nazi's going to harm them either! Not while John Masters is kicking."

## CHAPTER V

### *Lurking Enemies*



IN THE afternoon two Hurricanes lifted off the dusty field and curled over the wind-rippled expanse of Thingvellir Lake. Below them lay the moss-covered stretch of lava beds, like a Gargantuan piece of dirty and wrinkled green velvet.

At two thousand feet Masters kicked on left rudder and swung north. Phil Warren, sitting at two hundred feet above and slightly behind him, followed suit.

"Hey!" Warren suddenly yelped. "There's an explosion down there. See it—just south of that white house?"

"That's the well known geyser with a case of gas on his stomach." Masters grinned as he glanced down at the feathery plume of steam lifting into the air. "Before the war, tourists with nothing better to do traveled miles over those lava roads, and waited hours to see it pop. Then they squawked all the way back to town because it wasn't as big as Old Faithful."

Masters switched off Warren's frequency and left his companion talking to himself while he tuned up and down the short wave frequencies. A worried frown replaced his easy-going smile. With Warren choked off, he concentrated on the problem before him.

Back at the American and British bases he had checked all reports, hoping to find some little thing which might give him a clue to what M-11 was up to. But as far as he could

learn everything was serene. The only report of Nazi activity had come from an anti-aircraft battery commander to the north who had reported firing on a German plane a week or so before.

Otherwise, there was nothing to arouse suspicion. To all appearances the British and Americans had the situation well in hand.

Looking back toward Reykjavik, the Eagle could see ships clustered in the little harbor. Destroyers lay farther out, protecting the entrance, while supply ships lay close in, discharging supplies. The big American supply ship *Betelgeuse* was unloading a flock of light tanks and ammunition. Another ship was piling waiting barges high with food stores.

"If they are figuring on anything there'd be the place," Masters told himself. "Perfect spot for sabotage. Good fire along the docks an' we'd be needing a lot more transports."

He wondered over the situation for a moment as he watched the horizon to the north of him. The Nazis had planes capable of flying to Iceland from one of their many bases in Norway. They knew the ships were unloading there, perfect targets for well placed bombs. And the fact they had not attempted such a raid worried the Eagle plenty. It wasn't like Hitler's vultures to ignore a beautiful target.

He tuned back to Phil's wave-length.

"See anything?" he asked.

"Nothing but the roughest terrain I've ever looked at," Phil replied. "Know what I think?"

"What?" Masters asked. He was watching a bank of mist far out over the sea to the north.

"I think they planted this idea very nicely," Phil said emphatically. "From the looks of things there isn't a trace of trouble up here. They wanted you out of the way. Bet that stuff in the flask was a lot of mouth-wash."

"Still worrying about that date?" Masters asked. "Suppose you want to go back to London?"

"Gosh, no!" cried Warren. His voice made the phones rattle against Masters' ears. "I got a date."

"So soon?"

"Sure." Warren chuckled. "Meeting her this evening up by the monument. She's going to take me home to meet her folks and I'm going to have an Iceland dinner with all the trimmings."

"Did you tell her where you were going?" Masters asked quickly.

"Told her I was going fishing," Warren answered. "Promised her I'd bring her back a couple of herring. You know me better than that. I don't tell strange dames our business."

"You might soften at the mention of food, though," Masters said, as they roared out over the imposing mass of Snæfels-Jökull, one of Iceland's dormant volcanos towering over five thousand feet above the coast.

He glanced at the snow-covered cone and saw wisps of snow being torn away and streaming southward in a glistening spume.

"Wind'll be driving that bank of fog this way," he thought.

He turned to glance up through the cockpit hatch at Warren. Phil waved and pointed toward the snowy pyramid.

"Never mind the beauties of Nature, Phil," he called. "Keep your eye on that fog bank. It's heading toward the coast."

As Masters turned, his quick eyes caught a long, tapering shadow just under the surface of the rock-bound bay below them. He started nervously against his belt and then relaxed. Along the slope behind the bay he could see a rather large encampment, and the flag fluttering proudly from the staff indicated it was a Yankee outfit guarding the north approach to the island. In a field behind the tents and huts he could see a flock of light tanks parked.

He looked again at the sub he had seen, traveling well below the surface. Its outline was blurred. To any one

unfamiliar with under-water craft it might have been mistaken for a whale.

"Chances are it's a British sub patrolling the mouth of the bay," he thought. He reached for the switch to pull up the plane to ground frequency. "Better check with H.Q. just to make sure."

As his fingers touched the rheostat, his eyes narrowed. It didn't seem possible, but he was certain he saw a plane emerge from the bank of fog, then swiftly disappear again.

"Did you see that," Phil?" he yelled, forgetting the sub for the moment. "That was a Nazi!"

"Where?" cried Warren.

"To the north!" Masters shouted back. "Came out of the fog bank, then disappeared again."

"I didn't see it," Warren replied. "I was trying to figure out whether that thing down there was a sub or a whale."

"Up!" ordered Masters. "You get above the fog bank. I'll cruise along in front of the thick stuff. We'll nail him one way or the other."

"Okay."

"Yelp if you contact him."

Masters watched Warren bore for the clear crystal skies while he cut toward the face of the advancing mass of mist.

His fingers played with the dial, searching anxiously for the guttural Nazi voice.

Coming around in a steep bank Masters again caught the flash of black-crossed wings, and once more they disappeared. His phones picked up the hum of a transmitter as he hurtled toward the spot where the ship had faded into the fog.

"J-two-three-four-five . . . two-three-four-five," a voice was saying in German. "J-two-three-four-five . . . calling Sixty-three. . . . Calling Sixty-three."

Masters twirled the dial anxiously, hoping to catch a reply. Then he heard a voice, evidently completing a

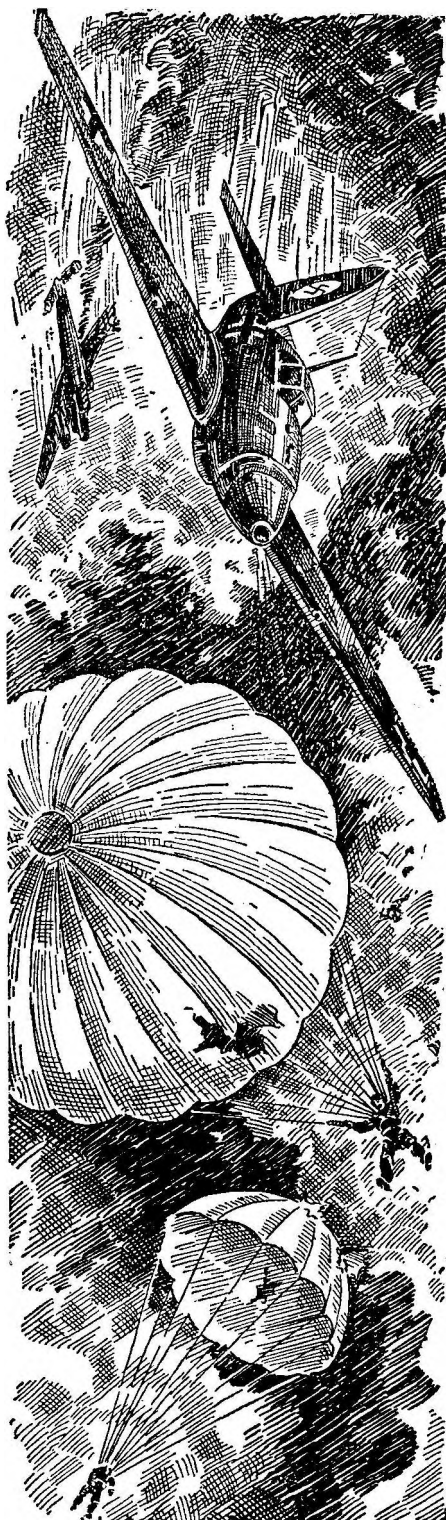

As the chutes filled, Masters heard the roar of the Messerschmitt (Chap. I)



sentence. But "—British plane," was all he heard.

He glanced over his shoulder. Far off in the distance he could see the bridge of a conning tower snuggling amidst the waves. The sub was lying low in the water, to forestall any chance of being seen from the shore.

"A U-boat!" grieved the Eagle. "Trying to contact that Junkers."

For a moment he hesitated. Then he snapped on the ground-to-plane frequency.

"Eagle Flight. . . Eagle Flight calling H.Q. Can you hear me, H.Q.?"

**A** CRASHING burst of tracer was his answer. They dirked the air around him like blazing darts, drilling through the hatch. In a flash his instrument board was a shambles.

"Come in Eagle Flight!" his phones said. "We hear you. . . . Come in please."

"U-boat off bay at head of Bredifjord," he shouted. "Trying to contact Nazi plane."

"Come in Eagle Flight. . . . Why don't you answer?"

"I am!" Masters cried. "U-boat in Bredifjord! Trying to contact Nazi plane."

"Come in, Eagle Flight. . . ."

"Phil, Phil!" Masters shouted, switching to plane-to-plane. "Phil, can you hear me?"

There was no answer.

Swinging wildly to escape a second burst, Masters checked again. His reception seemed to be all right. But a bullet had evidently found some vital spot in his transmitter.

A curse slipped from the Eagle's lips as he zoomed and came around in a half-roll. He was just in time to see the swastika-branded tail of the Junkers disappear into the swirling mist.

In the split second Masters poured a single burst into the weaving rudder. Then before he could bank, the cold gray stuff closed around him.

A chill coursed through his spine as he thought of what would happen

up there should the two crates brush wings. But he had little time to let his thoughts linger on danger. His eyes flashed to the instruments, held them focused, never once leaving the rate of climb or the turn and bank. Instrument flying in a Hurricane was anything but a holiday.

The breeze cutting out of the north tore at the stuff hiding his bobbing wing-tips. As he eased back on the stick in an attempt to climb above the fog, the Hurricane thundered into an opening torn through the blanket of fog by an eddying breeze.

A shadow loomed in front of him. For one wild second it seemed wing would meet wing. His thumb hit the button. His eight Brownings chattered angrily. His tracer caught at the tilted wings, held for a moment, then hissed into the mist.

The Junkers came around in a tight turn. The Nazi in the rear office opened up with his guns, hosing the Eagle with a cluster of blazing slugs.

Like a pair of gray flying squirrels in a gigantic cage the two ships chased each other's tail around the grim arena of death. The sibilant, rushing flight of bronze-coated missiles from Nazi guns sounded alongside the Hurricane. Masters could hear them smashing into the side of the fuselage like hornets gone berserk. He toed the rudder, threw the stick over and reversed his course.

For one wild, nerve-tingling moment it seemed as if the two ships must crash. But the Nazi gave way, forgetting his guns as he scrambled for safety into the enveloping fog.

With a curse Masters tore after him. His Hurricane bounced in the mad turbulent air thrown back by the Junkers' propeller. For a moment or two he was forced on instruments. Then the stuff thinned. Once again he broke through and found himself leaving the bank of damp gray below. The sun flashed on Hun wings just above him. He turned to get on the Junkers' tail, and saw a sight that

made him ill for the moment—a twisting column of black smoke, leading from the warm sunlight into the cold swirling mass below.

"Phil!" he cried. "Phil!"

**T**HEN he remembered his transmitter would not work. But the next instant he heard Warren's voice!

"Wrong guy did the contacting, John," Warren's voice sounded through his phones. "Came out of the fog like a jack-in-the-box and drilled me before I even saw him. He—" Warren's voice broke off.

Sweat poured from Masters' forehead as he closed in on the Hun crate.

Then Phil came in on the phone again.

"Kinda sorry I mentioned fishing to that dame. Looks like I'm headed for the playground of the cod. Boy, is it mucky in here! Listen for the splash. Getting hot. Got to bail out now. Here I go!"

That was all. Masters knew his companion had left the smoking plane.

"I'll get back to Reykjavik and get a patrol boat out," he thought anxiously as his thumb poised over the button. "His Mae West will hold him up awhile."

The Junkers was streaking south over the fog bank now. On the white mists below were two rainbows, and in the center of each the shadows of a plane. Bit by bit Masters began to creep up on the Nazi plane. Once again he heard the Hun pilot calling. Again somebody answered.

"It's the sub," he thought. "I'll hold my fire, close in, and see what's up."

Suddenly the Junkers dived. Masters threw his stick forward and followed after. Far down there he saw the shadow of the lurking U-boat. The Junkers was headed in that direction.

With his guns ready, John Masters poured after. He saw the Junkers circle the conning tower and a moment later something dropped from its fuselage. It was bulky at first

Then it unraveled. A small chute blossomed. And as it swung, his startled eyes caught something glinting in the sun.

"One of the flasks!" He cursed roundly. "Maybe more than one. Got a float attached to keep it on the surface."

He tried to cut in on the chute, hoping either to catch the shrouds on his wing or drill the flask and spill the contents before they would be of any use to M-11.

But the Junkers saw his intent. It came up at him, forward guns yammering. Then it banked. Its observer opened up, sluicing the air around the Eagle with blazing tracer. There was no time for tiny chutes or U-boats at the moment. Life was at stake. Not only his own but perhaps the lives of British and Yankee troops.

Twisting, turning, feinting the Hun into a maze of maneuvers Masters suddenly dived, then zoomed and came up directly under the Junkers. It was his pet trick with two-seaters, and he had the nerve to wait until it seemed as if his prop would churn the bottom of his victim into a mass of splinters.

**T**HEN his Brownings opened up. Just one quick minute-long squirt was all it took. The Junkers staggered as if in pain, then leaped skyward, only to fall away in a spin. A moment later it burst into flame and fell into the sea along the fringe of the fog bank.

When the Eagle leveled off and looked below, the U-boat was gone. Only a slight oil-slick and a few bubbles marked the spot. The small parachute and its gleaming cargo had also disappeared.

He glanced across the bay toward the American encampment, caught sight of the splash of red as the flag waved in the breeze.

"It's got to be kept waving," he muttered.

He banked and set his course for home. And that course took him over

the grouped tents and huts at the head, Breidifjord.

Looking down at the spot where his fellow countrymen waited to hold the Huns at bay, he nodded.

"That," he thought tensely, "is the logical spot for M-Eleven to start working. For it is also the spot at which Hitler should strike. But I'll be there first."

## CHAPTER VI

### *M-11 Strikes*



INNER JONSSON'S majestic statue of a Viking warrior threw a lengthening shadow over the little square on the hill above the harbor. Sitting on the stone steps along the westward side of the statue were a group of old women who had taken their places to knit and gossip.

On the pile of stones just under the steps sat a stoop-shouldered old man whose chin rested on his knuckles cupped over the gnarled end of the piece of carved driftwood he used for a cane. Now and then a child stopped, his black eyes opening in wonder as he stared into the unseeing, gray-filmed orbs of the ragged old man.

He kept his face turned toward the harbor where British and Yankee ships continued to unload the weapons of war.

A bit to his left sat an old woman. She did not join the others in their chattering gossip. When her eyes were not busy with her knitting they were focused on the road leading up the hill from the town. Occasionally they paused to scrutinize the old man sitting by himself.

Suddenly a civilian appeared on the scene from around the corner of the statue. He stood looking over the square, his eyes half narrowed in a puzzled frown. Now and then he lifted his arm and sniffed at his sleeve. Then his face puckered, his nose wrinkled,

as if he had smelled something unpleasant.

The old woman put away her knitting, got stiffly to her feet and walked toward the young man.

"Are you Philip?" she asked in halting English.

"Yes," said the man. His face lighted in a smile, then sobered. "Don't tell me Ingar isn't going to meet me."

The old lady fished in her knitting bag and produced a square of folded paper.

"She send you a letter." The old woman held it out to him. "You are sure you are Philip Warren. You must be. Ingar said you are very handsome."

Phil Warren took the letter. His eyes were anxious as he unfolded it, then they brightened as he read:

Dear Philip:

I could not come to meet you myself. I stayed at home to prepare dinner for you. This is my Aunt Hilda. She will see that you get a taxi, and will give directions to the driver how to reach our house.

And, Philip. I promised my aunt I would ask a favor of you. She is making a quilt with signatures on it. Will you write your name on the piece of prepared paper she has? Use the ink she has in her pen. It is special ink so she can make a transfer to the goods and then embroider it in silk.

Hurry! We will all be so glad to see you.

Ingar.

Phil smiled. "So you want my autograph," he said.

"No, your name," she insisted, holding out a slip of paper to him.

"Okay. Let's go over here by the steps," Warren said. "Can't give you a good signature standing up."

They went over to the granite steps and sat down. As they did the group of old women sniffed, looked at Phil, and got up. As they stalked away Warren looked from them to the old lady at his side.

"Do I smell that bad, Aunty?" he asked.

"Smell?" she asked.

"Yeah." Warren frowned. "Spent



most of the day on a fishing boat. Picked me up out there and brought me in. Got this outfit well messed up. Couldn't buy another because my pal's got my dough."

"But you must expect to smell of fish." The old lady smiled. "Ingar said you had gone fishing. What is this pal—a baker?"

"Not that kind of dough, Aunty." Warren grinned as he took the pen. "Make any difference whether I sign it catty-cornered or not?"

"No, just your name," the old lady insisted. "Nothing else. Hurry—there is a taxi waiting."

**P**HIL laid the note on the stones, rested the slip of paper on his knee and slowly wrote his name. As she took the paper he fumbled with his pocket.

"No," the old lady said quickly. "It is my pen."

Warren looked at the pen. A puzzled frown crossed his face as she reached out and took it from his fingers.

"Come, Philip," she said, getting to her feet. "There is a taxi—Ingar is waiting. Come—hurry."

She took Warren's arm and walked to a cab waiting at the corner where Laugas Vegur touched the square on an angle.

Warren got in. The old lady gave hurried directions to the driver. The cab started up, but not with the usual noisy rattle of an Iceland car. This one seemed to purr as it glided away from the square and disappeared down Loekjargata. Then it was gone from sight.

The old lady watched it a moment, then started around the other side of the monument and headed toward the little gray cathedral.

As she passed from sight behind the monument the old man rose slowly. He tapped his way around the steps, feeling every step with the cane. His ugly, gray-filmed eyes stared straight ahead. He moved down the slope and

headed toward the Althing where the Iceland parliament met.

Then he, too, disappeared. . . .

An hour later the old man appeared in an alley leading toward the rear door of the building in which were housed the American administrative offices.

"Scram, old-timer," the sentry said brusquely. "No beggars allowed around here."

"I've got to see General Tremaine at once," the old man said.

The sentry's eyes narrowed. "You know a lot, don't you! Too much." He reached out and grabbed the blind man by the front of his ragged coat. "Corporal of the guard! Come here!"

"What's up?" asked the N.C.O.

"This old duck knows too much," said the sentry. "We were ordered to keep the general's whereabouts a secret. Wasn't to be known he landed in Iceland today by plane. And now this blind geezer comes along, not only to the right place, but asks for him by name."

"Nice work, Rafferty," growled the corporal. "I'll take charge of him. Come along, you."

He grasped the blind man by the arm and yanked him inside.

"What's this?" asked General Tremaine, as the N.C.O. shoved his prisoner inside.

"Caught him snooping around," the corporal said importantly. "Figure maybe he's one of these Fifth Columnists."

"Very well, Corporal," said Tremaine. He scratched a match and held it carefully to the stub of his cigar. "I'll question him. That'll be all for the moment."

As the noncom closed the door, the blind man moved swiftly toward the desk.

"Still smoking rope, hey, General?"

Tremaine grinned, and put the cigar stub in the ash tray where it rested with half a dozen others of the same length. That one comment was all that was necessary to tell him the real

identity of his tattered visitor—if there had been any doubt. Only one man had consistently ragged him about his predilection for cheap stogies, and for the almost penurious way he held on to them to the fag end, for so long that mention of it was almost a pass-word.

"Been sitting here waiting for you to contact me, John," he said, after a moment.

**H**E WAS the same Tremaine he had been in World War I, when he had been John Masters' commanding officer. Though he was General Tremaine now, and a big shot in the Intelligence Department in the War Office in Washington.

Through thick and thin, though, these two still worked together, as they had in the old days when the American Eagle had been the greatest standby of the Allies, as he was fast becoming to the oppressed in these days of a war-torn world. General Tremaine knew that, and would circle the globe, if necessary, to answer a summons from the Eagle.

"Just a minute till I get these blasted lenses off my eyes," Masters said.

In a moment the two curved bits of gray unbreakable plastic resembling glass lay on the desk. Tremaine picked one up and squinted at it.

"Sure is a small hole in this gray stuff," he commented.

"I manage to see, though," said John Masters, as he dropped the torn coat he had been wearing on a chair. "Best little things for a disguise I ever picked up. With them, I can pass for a blind man in any company."

"What's new?" Tremaine asked soberly, as he laid the bit of plastic back on the table.

"They—those rats I sent you that message in code about—just got Warren," Masters said, suddenly sober himself.

"Why, I got a report that a fishing boat picked him up and brought him

in this evening!" exclaimed Tremaine. "They sure worked fast."

"He fell for the promise of a big dinner," said Masters. "I knew he had the date, and sort of had a hunch they might be trying to get at me through him, so I was on hand at the place he said he was going to meet the girl, when he showed up there."

"What did they do—slug him?" asked Tremaine.

"No," Masters said. "Nothing as crude as that. Done very neatly. He got in a taxi, thinking he was going to have dinner with some Iceland beauty and her family."

"Who engineered it?" demanded Tremaine. "I've been checking an' double checking all afternoon. There doesn't seem to be a trace of trouble, not even a stray Fifth Columnist. I was beginning to think somebody was pulling the red herring trick. Who got him?"

"R-Forty-seven," Masters said quietly.

"Which one?" demanded Tremaine. "Don't tell me that vicious young one is on the loose again."

"I only saw one of them," Masters said after a moment. "But I've got a hunch both of them have their fingers in this mess."

"Both of them!" exclaimed Tremaine. He leaped to his feet and confronted the Eagle. "One is bad enough any time. But two of them—mother and daughter. . . . Which one did you see?"

"The mother," said Masters. "She handed Phil this note. I picked it up after they left. Don't know whether Phil did it deliberately or not. An' I'll bet a ton of cod to a herring this Ingar is the younger R-Forty-seven."

Then the Eagle related the little scene he had witnessed up on the hill by the monument.

"The daughter was afraid she'd be recognized," Tremaine said when Masters had finished. "So the mother pulls this aunt trick."

"And got away from me," growled

Masters. "Must have had another of those fast cars waiting. The bus Phil left in was no ordinary taxi. That thing had power under its battered hood."

**M**ASTERS spread the note out on the desk and both studied it for a moment.

"But this gag about a signature," Tremaine said, as he reached for a fresh cigar. "I remember my mother making one of those quilts. Sent all over the country for autographs. Darned if I can remember her using any special ink though."

Masters was not listening. He suddenly stooped, sniffed the paper. His nostrils quivered as they picked up a sweetish odor.

"Dutranamide!" he cried. "We're on the track! Here, take a whiff of this. This paper's been around some of that dutranamide."

"Smells like one of those dizzy perfumes the women sprinkle themselves with," growled Tremaine. "Suppose they'd call this one 'Night in a Clover Patch!' Say what is this dutranamide anyway?"

"I only wish I knew," Masters said softly. "I had a flask of it in my hands a few nights ago. But it's got something to do with this."

"With what?" demanded Tremaine. "You flash me an S.O.S. to Washington to come up here. I hop a flying fortress and get here the next day and

find everything peaceful as a Sunday School picnic. What do you think's going on?"

"That," Masters said slowly, "is the devilish part of it. On other occasions we've had an idea of what the menace was, so all we had to do was stop it. This time we only know they're getting ready to pull *something*, and haven't the slightest idea what it might be."

"And we've got to stop them before they get into action," said Tremaine, drawing hard on his recalcitrant cigar. "If it wasn't for the fact that they worked overtime to get Phil out of the way I'd say we were barking up the wrong rain-spout. That angle tips us off that something's afoot. Maybe this dutranamide is a powerful poison. Might be planning on slipping it into the food or the water supply. Knock our troops out on this, their first job away from home—and wouldn't the fireworks sputter in Washington!"

"That's why it's so important to stop them in their tracks," Masters persisted. "Whatever they intend to pull is big. They wouldn't have both R-Forty-sevens on the job if it wasn't."

Tremaine's eyes narrowed. He chewed viciously on his cigar a moment.

"You know, John," he said. "If they pulled this gag on Phil, why couldn't they have worked the same a dozen

[Turn page]

*Rip-Roaring Action on Every Page of Our*

*Companion Magazine*

COMING IN THE JANUARY ISSUE

**WINGS FOR A COFFIN**

*A Complete Full-Length Novel of  
the Cloud Musketeers*

**By T. W. FORD**

Plus Other Stories and Features

° SKY \*  
**FIGHTERS**

Now on Sale 10c at all Stands

times on both American and British men by now?"

Masters nodded. "I was coming to that. Only wish they'd picked on me instead of Phil."

"You think then they're using Warren for bait?"

"Sure of it," Masters said.

"And?"

"I'll go after the bait," snapped Masters.

"That blind gag is only good once," Tremaine said slowly. "Folks around here would ask questions about a strange blind man showing up too often."

"I'm not using that again," Masters said as he walked over and studied the map. He was silent a moment, then said abruptly: "I figure the place they'll go into action is around Breidifjord. That's where I'm going."

"How?" demanded Tremaine.

Masters turned to the general. "Have any reports got out of England about a German pilot escaping?"

"You mean the one that got away from a patrol boat, stole a fishing boat, then swiped a seaplane from the Kirkwall seaplane base? Beats me how the papers got the story past the censors."

A broad smile crossed the Eagle's face.

"That's all I want to know," he declared. "Mr. Churchill promised me he'd see the news got out. I promised him I'd stop these devils and their dutranamide. I'm going to keep that promise, General."

## CHAPTER VII

### *Checkmate*



FEW hours later a British cruiser steamed out of the Iceland harbor and set a course due west.

And while the cruiser headed for the horizon, where the rim of the midnight sun was still visible, British Hurricanes back on the little Thingvellir airdrome were be-

ing fueled, their gun-belts loaded with ammunition. The pilots sat in the hut ready, waiting, their Mae Wests fastened snugly around their chests.

Under forced draft the cruiser lashed the icy waters into a froth, cutting straight for the spot where the sun had already started its upward swing.

"You understand," Masters said as he stood by the catapult talking to the commander, "that as soon as I'm off I want you to wireless that you have sighted a strange seaplane which refuses to answer your signal. Pour it on strong that you suspect it to be the one stolen from the Kirkwall base. Whatever you do, don't mention type. If this M-Eleven knows planes he'll get suspicious. Might know a Sea Fox couldn't fly this far without refueling."

"I understand." The commander smiled. "The men on shore are waiting for—the signal. They'll meet you at eight thousand."

"That's right." Masters turned toward the ship's M.O. "Ready with that bandage?"

"Yes, sir." The ship's surgeon smiled too. "I can put it on in a jiffy."

"Might as well put it on now," said the Eagle. "Have to dirty it up pretty well, although you seem to have done a good job already."

"Weak tea, a little oil, dust rubbed in and dried on the boilers," the M.O. said, as he started to wind the soiled gauze around the Eagle's head. "When I get it on it'll look as if you've worn it a week. You want the left eye covered, I understand?"

"Right," Masters said. "Cover as much of my face as you can. Leave me one eye." He turned to the commander. "How do you like my uniform? Not bad for a hand-me-down, is it? Poor Kurt, he's putting up with a lot on this show."

When the doctor had finished, Masters held out the silver identification disk he had taken from Kurt von Gelsen,



"Mind snapping this on?"

"There you are, sir," the doctor announced as he fastened the fine metal chain around the Eagle's wrist. "Now you're a pukka Nazi."

"Take care, sir," the commander advised anxiously. "Don't get in the way of one of the bullets. Don't like it a bit, your mixing it up with them and then deliberately crashing in the sea. Although according to our charts the current will carry you toward the mouth of the bay."

"Don't worry," Masters said, and climbed up on the catapult frame. "In this racket we've got to take risks. There's a lot at stake. Can't have them throwing a monkey-wrench into the works at this stage of the game."

Crawling into the cockpit of the *Fairey Sea Fox* Masters tightened his Mae West over the Hun uniform he had taken from von Gelsen. His eyes swept over the dials. The motor was warm. Everything was set. He was ready to take the grimmest gamble of his career.

He raised his hand. The seaplane moved forward as if shot out of a gun. It dropped sickeningly for a moment, then picked up flying speed. Circling the cruiser, he waved to the commander and began to climb, setting his course straight for the fjord.

**H**E HEARD the commander send out the alarm. In a moment or so the airfield at Thingvellir answered.

"Now for the fireworks." The Eagle smiled.

Far ahead of him he could see the snowy peaks pushing their heads above the horizon. Holding his course, Masters kept watching over his right shoulder. He had a rendezvous up there, a grim bit of make-believe by which he hoped to locate the mysterious M-11 before any damage could be caused.

Suddenly they were on him—flashing gray wings coming out of the west. He could hear the pilots chattering on the plane to ground fre-

quencies. That was the way he had planned it.

Tracer whipped the air around him into a froth of smoke. Ships twisted madly as pilots sought to get on the tail of the slower biplane. Then they zoomed, spilling burst after burst into the gray clouds.

"He's the Hun!" he heard a pilot shout over his plane-to-plane. "Good, too . . . Just got Hankins."

Masters grinned. He hadn't fired a shot. But a plane had fallen out of the fight, twisted into the clouds and disappeared.

"Trying to drive him toward shore!" somebody else yelled. "Blighter won't drive, though. Have to knock him down for keeps."

The skies trembled as the eight Brownings in every pair of wings opened up, throwing a skein of curling tracer into a fleecy cloud.

"Ought to hear that from shore," Masters thought grimly.

He waved to the squadron leader flashing overhead. He wished he could tell the young Britisher he was putting up a good show. But there could be no communications between the seaplane and the Hurricanes. For he hoped somebody back there along the fjord was listening.

Time after time the Hurricanes dived, then zoomed. The young R.A.F. lads seemed to be enjoying the show. They made plenty of racket with their blazing guns. And to anyone below it might have appeared to be a thrilling fight, a single seaplane battling against odds.

At last Masters raised his fist, opened his hand and spread his fingers. The Hurricanes scattered as he zoomed, pulled into a stall, then threw the plane into a spin.

"We got him!" he heard the squadron leader's voice come in over the phones. "He's going down out of control!"

Holding the stick back against his thigh and kicking hard on opposite rudder, Masters held the ship in a

tight spin and bored his way right through a cloud. Just before he emerged he yanked on a wire along the cowling.

When he hit the clear he glanced over his shoulder. A spiral of thick black smoke was unraveling behind him. A pleased smile played across his face.

"Smoke bombs make a nice bit of camouflage at times," he muttered.

He began to ease the stick forward and neutralize the rudder. The plane turned, slower and slower, as it neared the sea. Then a quick jab on opposite rudder and she straightened out. Back on the stick, easy at first. The nose came up. She leveled out as a wave reached for the pontoons. He held off, let her settle slowly and finally splashed in.

"Now for a cold bath," he thought, with a shiver.

He unfastened his safety-belt and crawled out on a wing. He paused there to yank the ring on a grenade and toss it into the rear cockpit filled with oil-soaked waste. Then he dived.

**T**HE cold water drove the breath out of his body as he clawed against the pull of his Mae West. A dull thud reached his ears as he came sputtering to the surface. The fuselage of the plane was burning furiously. With a few strokes he was back. He pulled a hatchet out of his belt and swung at the port pontoon, cutting half a dozen gashes along its length.

The plane started to settle even before he reached the starboard pontoon. He gave that the same dose, then let the hatchet slip from his fingers and struck out toward the hills guarding the distant fjord.

Looking back over his shoulder he saw that the ship had disappeared completely. Only a wavering column of smoke marked the place where he had set down.

Every time he crested a wave he looked anxiously toward shore. The

next act in the little script he had prepared should take place soon. He was depending on somebody along the far shore being a bit anxious over the fate of the plane which was supposed to have been stolen in Kirkwall.

It seemed an eternity before he caught sight of a boat speeding toward him. Two waves crested away from its bow as it cut the cold gray water.

"About time," he chattered.

He kicked himself half out of the water and waved. The boat turned a point on its course and came toward him. Then he saw them—khaki-clad figures.

"Americans," he moaned in bitter disappointment. "Figured M-Eleven would try to get to me first."

Eager hands reached for him and pulled him into the launch. He closed his eyes and slumped to the floor. Even though they were Yanks he was going to play the game as he planned it. If M-11 was in the vicinity he would no doubt make a try at rescuing him. Yes, that would be the angle to play.

Somebody took hold of his wrist, turned it, then let it drop. It was the wrist on which he wore Kurt von Gelsen's identification disk.

He faked a groan and pushed himself to his knees. He pressed his hand to his bandaged head and looked at the three men in the boat.

"*Gott verdammt!*" he muttered. "*Amerikaners!*"

The two soldiers glanced at the officer at the stern and laughed, but for some reason the laugh did not ring true.

Still pretending he was dazed, Masters pulled himself up and sat on one of the cushioned seats. It gave him a good excuse to scrutinize the three men.

"You are *Amerikaners?*" he asked the man nearest him.

The Yank shrugged.

"I vos in Amerika vonst," Masters said slowly, keeping his eyes glued on

those of the man at his side. "I speak goot Eengliche, no?"

"No," said the American.

"Froom vere in der United States do you come?"

The man's eyes narrowed. A frown crossed his face. His tongue licked nervously at his lips.

"We're going back soon," he said after a moment.

"Back vere?"

The man stared at Masters. "Don't you know?"

"Know vat?" demanded Masters watching the man's face.

"We ain't staying."

"Can that," the officer said over his shoulder. Then he turned back to navigating the launch through the fjord.

"We ain't allowed to talk yet," whispered the soldier. "We got orders, we have."

"Orders from who?" Masters asked slowly.

"Colonel McGuire, of course." The soldier grinned. "Who'd you think."

**M**ASTERS knew that if any orders were to be issued they would come from Colonel McGuire who had command of the detachment stationed there. He had checked that. He knew the names of every officer in the personnel of the group. Every one of them were above reproach. Yet his mind raced. The man's answers had been evasive, incoherent.

He sat there alone, watching the shore draw closer. He could see the huts, the clustered tents, the park full of tanks with guns pointing toward the sea. Here and there on the hills were anti-aircraft batteries—Bren guns, Bofors, three-inchers that could hurl a chunk of steel four miles into the air with deadly accuracy.

Then his eyes came back to the other in the boat with him. They kept their faces turned away. There eyes avoided him. There was something handdog about them, something decidedly suspicious.

"I wonder," he mused, as he watched them out of the corner of his eye. "Could the Nazis have Fifth Columnists planted up here already? These guys know something—something I'm going to find out if it's the last thing I do."

Then his eyes fell on the flag flying over headquarters. His heart swelled. He would do all in his power to keep that flag flying over those far distant ramparts.

The launch slid up to a temporary dock.

"Any luck?" a tall gray-haired officer asked.

"We picked him up, Colonel," the officer at the wheel said. "Plane sank though. I'd say he was a lucky bird."

Masters looked up at the colonel standing on the planks above him. One of the soldiers motioned for him to climb out.

As Masters reached the dock he stiffened. "I am *Leutnant* Kurt von Gelsen," he said slowly.

"Come along," the colonel ordered gruffly. "I'll question you in my office. That'll be all, men. I don't think he'll try to escape. Wouldn't get far if he did."

When they reached the colonel's quarters and the door of the office closed on them, the colonel whirled.

"*Heil* Hitler!" he snapped, and his arm stiffened in the hated salute.

"*Heil* Hitler!" Masters answered.

He brushed his hand across his mouth. He felt nauseated, had all he could do to hide his astonishment.

The colonel reached out, took the Eagle's wrist and exposed the identification disk. He read the name, then turned on the bedraggled prisoner.

"You failed, Kurt von Gelsen," he said crisply. His voice was cold, as if he had a mouthful of cracked ice.

"I was shot down by a cursed English pilot," Masters replied. "My escort failed me. But I managed to escape, even though I was badly wounded. I wanted to be here to help."

"You were almost too late," snarled the colonel. "A plane managed to get through with two more flasks yesterday. We have everything prepared. The dutranamide has been distilled and merged with my M-seventy-five formula. It is already at work."

The colonel stopped. He studied what was visible of the Eagle's face and started to laugh.

"Why do you laugh?" Masters asked anxiously.

He was still trying to figure out how a man with Colonel McGuire's record could possibly have swung in on the Nazi side. If such a man as this were a Fifth Columnist, surely there must be some even higher up back home.

"I was laughing at what your father would think." The colonel chuckled again. "He and his precious dutranamide! The most marvelous local anesthetic in the world, he claimed. A boon to mankind. He little dreamed that when I helped him develop it I was already working on the idea of combining it with my formula M-seventy-five. And now you, his son, are helping."

**T**HE colonel stopped. He stepped forward and grabbed Masters' arm.

"The others are on the way," he said tightly. "The rest are ready. Tomorrow we strike. America will be dumbfounded. There will be a cry from one end of the country to the other that their men must be kept at home. And that is where they belong! We are ready to teach the cursed Americans a lesson, a lesson they'll never forget. Their yellow-livered appeasers will have their day, people will listen to them. The morale of the American troops will be broken."

"Yes, I know," muttered the Eagle, as his mind fought to piece this weird puzzle together.

"They are playing right into our hands," the colonel said gleefully. "This campaign to let their draftees

go, after a year's service, is perfectly timed. It will go through after they hear of what happens tomorrow."

"But it may make the Americans angrier," Masters cautioned. "They are a peculiar people. Even these men who shout appeasement may change their minds."

"But the seed will be planted, and kept growing through the efforts of our efficient propaganda department," said the elated colonel. "They think they will stop us because they send home a boat-load of dumb consuls. Why, after tomorrow, when we have—"

The opening of the door interrupted the colonel. Masters silently cursed the officer standing there. He was certain the overconfident colonel had been about to give him the key to the riddle.

"The old woman and her daughter are here with the eggs you ordered, sir," the lieutenant said slowly. "Will I tell them to wait?"

"No—bring them in," said the colonel expansively.

Masters felt the skin at the back of his neck ripple. He knew very well who the old lady and her daughter would be.

"As I was saying," the colonel went on, "after tomorrow when we have—"

"Stop, you fool!" came a harsh order from behind him.

"Why, *Fraulein!*" gasped the colonel. "This is Kurt von Gelsen. The professor's son who escaped from the British."

"Have I not warned you?" snapped the older of the two women. "The Eagle is about. This Philip Warren we have captured is his companion. Where you find one you will find the other."

"But we picked this man up out of the sea," the colonel persisted. "He was shot down by the British off shore, as he tried to reach us. See—he carries the silver identification disk. He is one of us."

That was when Masters noticed the



colonel also had a silver disk on his wrist.

The younger of the two women leaped forward. As she looked at the disk on the Eagle's wrist she uttered a shrill cry. Her finger trembled as she pointed to a white scar running across the back of his hand, an old Spandau wound from World War I.

"*Mutter! Mutter!* The scar! It is he!" The younger woman dropped his hand. Her fingers clawed at his face as she ripped away the bandage. "See? It is the Eagle!"

"*Du bist ein Aesel.*" The older one cursed as she snatched the falling bandage and threw it in the colonel's face. "We came just in time."

"We meet again, *Frau* and *Fraulein.*" Masters grinned as the colonel stared at him incredulously.

"For the last time," the younger R-47 hurled at him.

"I hope so," Masters replied.

"Kill him at once!" screamed the elder R-47. "Kill him! I order you to."

Reaching behind him, the colonel picked up an automatic. He glanced from the gun to the calm face of the Eagle. A crafty smile slipped across his face.

"You made a fool out of me," he said slowly, as he fingered the gun. "I should kill you. But I will enjoy my revenge much more by making a fool out of you."

"Kill him!" the two women chorused. "We know him. He is slippery as an eel in a tank of oil."

"Wait!" The colonel motioned for them to be silent. "Do not forget that I am in command here. This is my scheme. You were only sent here to help. I will do things my own way. Imagine the effect it will have on the people in America when they learn their precious Eagle was one of those who . . . Silence! I give orders here."

The two women looked at each other and shuddered, then shrugged.

"This, Colonel," the younger R-47 said slowly, "is where you are making

your big mistake. Up to now your plan has been perfect. Now you oil the wheels of failure."

"No, *Fraulein.*" The colonel smiled wickedly. "Now I will avenge the Fatherland for all the grief this man has caused it."

He motioned toward a door at his left with the gun.

"Through there," he ordered. "Quick!"

Masters glanced at the two horrified women, bowed low, and walked toward the door. The colonel was right behind him, pressing the gun into the small of his back.

"Open it!" snarled the officer.

Masters opened the door and stepped through. Dimly, he heard the two women cry out. Then the world seemed to explode in a mass of flame. Something extinguished the flame. Everything grew dark. He seemed to be falling into a well a thousand miles deep.

## CHAPTER VIII

### *The Eagle's Ruse*



WHEN the Eagle dragged himself back into the world of reality, he started to open his eyes, then closed them again as he heard two men talking at the other side of the room.

"Give him everything," came the voice of Colonel McGuire. "If he should escape when things happen tomorrow I want him fixed so he will never bother us again. You understand? It is an order."

"I understand, sir." The voice of the unseen man who answered was hollow, lifeless.

"Good!" snapped the colonel. "Now I must calm those hysterical women."

Masters heard a door close. He let his eye lids flutter to slits. His head throbbed. There was a sore, aching spot where something had cracked down on his skull. The barrel of an

automatic, he figured, as he looked around the room.

From what he could see he judged he was in the depot operating room. Yet despite the glass instrument case he saw, and the metal table on which he lay he could not reconcile the fact that the walls were stone, the folded mass of an old lava stream.

"Cave of some sort," he muttered.

He held his breath as a gray-haired man in the uniform of a major in the American medical corps came toward him. In one hand the man held a hypodermic containing about ten cc. of clear waterlike liquid. The man laid the needle down on a table beside a basin of water and a bottle of alcohol. With a cotton swab he washed an area just behind the Eagle's ear and dropped the wad into a bucket.

Masters' muscles tensed. He took a deep breath as the medical officer reached for the needle. The time had come for action.

But just then an orderly stepped into the room.

"I think that guy in Number Six needs a shot of adrenalin, Major," the orderly said quickly. "Better come quick. You know we had orders he was to be kept alive."

The major laid the needle back on the table, felt Masters' pulse, then hurried toward a cabinet next to the instrument case. Masters saw him take out a rubber-stoppered bottle and another hypodermic.

"This fellow's still out cold," he said to the orderly. "I'll tend to him when I get back. Come along, Smith. Need your help."

The moment the door closed, Masters was on his feet. He grabbed up the hypodermic and slipped it into his pocket.

"Not jabbing me unless I know what's in the needle," he growled.

Hustling over to the cabinet he opened the drawer and found another hypodermic. He attached a needle and then went to the medicine cabinet. There he found a bottle labeled

"DISTILLED WATER," uncorked it, slipped the needle in and pulled the plunger. Replacing the bottle he held the needle to the light, squirted a tiny jet of water into the air to eliminate bubbles and then went back to the table. He put the needle down on the towel and stretched himself out as he was when the major left the room.

"Hate to be jabbed," he muttered. "But this is once I'll have to take it."

He felt of the needle in his pocket and relaxed as the M.O. came back into the room.

As he lay waiting he wondered what his cue would be. He was not certain just what effect the drug was supposed to have, whether it was just to stun him or lay him out cold.

And while he tried to dope out some solution to the problem, the doctor shot the needle home in the muscle of his neck. He gritted his teeth and waited for that cue. Finally the M.O. slapped his cheeks.

"Come on—snap out of it!" he ordered.

**M**ASTERS opened his eyes slowly and looked up into the eyes of the gray-haired officer bending over him. They were kindly eyes, and that puzzled him too.

"Sit up," snapped the doctor. "That's an order. You follow orders now. Sit up."

Masters pushed himself to his elbows, hesitated a moment, then sat up.

"Now stand up," the doctor said.

Masters slid from the table and stood confronting the doctor. He looked into the man's eyes and saw the same thing he had seen in those of the men on the boat. They were queer, dull, submissive.

"Walk across the room."

Masters walked slowly across the room.

"Stop! Turn around."

Masters turned just as the door opened. He saw Colonel McGuire standing there. A broad grin lighted the officer's face. His eyes gleamed.

They were different than the eyes of the others. Strong eyes, eyes that commanded.

"Ah, I see he is ready," snarled the colonel as he watched Masters walk toward the major. The colonel rubbed his hands together in anticipation. "This is the greatest moment of my life. . . . Come here, you, Masters. Here in front of me."

Masters went over to the colonel. He fought to hide the hate welling in his heart. Enemies were bad enough.

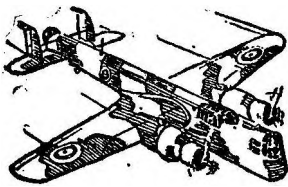

But traitors, slinking snakes such as this, filled him with loathing.

"Heil Hitler!" cried the colonel, raising his hand.

"Heil Hitler!" echoed the Eagle.

The price was awful, but no price was too great if he could learn the details of the colonel's dastardly plan.

"Wunder bar," breathed the colonel. "He will lead them. After all these years his name will be despised even amongst his own people. A hero has fallen from his pedestal." He stared at the Eagle. "About face," he ordered. "Walk over to the door."

The skin on Masters' scalp grew taut. He had walked through a door just a few moments before, and his skull still ached.

"Open it!" commanded the colonel.

Masters opened the door and choked back the gasp of surprise welling to his lips. For, rising from a bench, was Phil Warren.

"Come out here, Warren," ordered the colonel.

Warren stepped into the room and confronted Masters. There was no recognition in his eyes.

"Do you know this man, Warren?" the colonel said, pointing to Masters.

Warren shook his head. He looked stupidly at the Eagle.

"Have you ever seen him before?"

"No, sir," Warren said humbly.

"And you?" asked the colonel, turning on Masters. "Do you recognize this man?"

"No," Masters said dully, as he studied Phil's face.

"It is amusing." The colonel grinned. "We will put them in there together. It will be ironic to say the least. These two together and they will not be able to plan."

Walking up to the two Americans, he looked them full in the eye.

"Now understand," he said sharply. "This is an order. You will be placed in that cell together and you are not to talk. Is that understood? Not a word from either of you. Tomorrow you will be released, and you will help to bring the world crashing around American ears. You understand the order?"

"Yes, sir," Warren said.

"Yes, sir," Masters said subserviently.

"Good," chuckled the colonel. "About face. March!"

**T**HE two men turned and walked to the door. It closed behind them. They stood in utter darkness.

Masters stood listening by the door. As the other door to the operating room in the cave closed he felt Warren's hand on his arm.

"How you doing, John?" Warren's voice came out of the shadows.

"Phil!" Masters gasped. "Are you all right? Were you putting on a show, too?"

"Gosh!" Warren whispered. "Then you're all right?"

"Certainly," Masters laughed softly. "Except for a thimbleful of distilled water in my neck. Say what's this all about? What are they getting ready to pull?"

"I don't know," Warren said softly. "But I managed to see part of this camp of theirs before I was locked up."

Those troopers out there look more like sheep than soldiers."

"Must be drugged!" the Eagle exclaimed under his breath. "Doped, so they'll follow this devilish Colonel McGuire's orders. Of all the rotten Fifth Columnists he's the worst I've bumped into so far! By the way, let's start at the beginning. What happened to you?"

"You saw me get into the taxi," said Phil. "I spotted you. That's why I left that note so you would find it."

"Did you know R-Forty-seven was around?"

"Wasn't sure," Warren whispered. "But while I was floating out there in the water my brain got to working in high gear. Guess the cold water did it. Got trying to figure where before I'd seen this Ingar dame I was planning to meet. And it came to me that she was R-Forty-seven! That's why I hustled up to the monument to keep my date. Couldn't find you, so I went out on my own."

"And that fountain pen was a gas gun," interrupted Masters. "How'd you keep away from it?"

"It felt funny," said Warren. "Too heavy for a regular pen. And as I pressed the point to the paper I felt something click. So I exhaled just as a vent opened in the top. I couldn't see any gas, but I could hear it."

"Get a whiff of it at all?" demanded Masters.

"Some got on my coat," said Warren. "Here—you can smell it yet. If I was anywhere but here I'd feel embarrassed."

Masters took the cloth between his fingers and sniffed. Once again he caught a trace of that sweet, cloying odor.

"Dutranamide!" he murmured. "Yep, some of that green stuff is there. Mixed with this M-seventy-five it becomes clear. What happened next?"

"I dropped the note and got in the cab . . . And say, could that bus travel?"

"You took your cue about obeying orders from R-Forty-seven then?" Masters asked.

"R-Forty-seven!" exclaimed Warren. "Don't tell me that old dame was R-Forty-seven." He whistled softly. "I get it. The two of them are working on this job."

"Right," snapped Masters. "And the way I see it they've got everybody hopped up with this mixture of dutranamide and M-seventy-five. The dutranamide, from what I could learn, is a powerful local anesthetic. Combined with M-Seventy-five why couldn't it be used to numb a man's brain, make him follow the orders of the man who gave it to him? Evidently they are using two methods—gas and as a liquid. You were supposed to get it through the nose, and I got it in the neck. Mine is supposed to be a permanent treatment."

"I think you've got something there," murmured Warren. "That would account for the way the soldiers look, and the way they obey strange orders."

"And to stop it we've got to get out of here and go into action!"

**M**ASTERS started toward the door, but Warren held him back.

"Listen, John," he cautioned. "I've been doing some exploring. There's a fissure at the back of this cave. I squeezed through and got into a sort of tunnel. Maybe we can get out that way."

"Let's go then," Masters said. "According to what this rat McGuire said, they're striking tomorrow."

"Got any idea what they're up to?" Warren asked as he led the way to the rear of the cave.

"Not the slightest." Masters hesitated. "Say, one of the soldiers in the rescue boat mentioned something about going home. Acted sort of queer when I tried to question him." A low whistle escaped his lips. "Mutiny! Maybe worse."



## CHAPTER IX

*Turn About*

FOLLOWING Warren through a twisting fissure in the lava, Masters soon found himself in a narrow tunnel through which water had poured in ages long gone by. Working their way through the dark, stumbling over water-rounded boulders they soon came to a branching tunnel.

"Seems lighter down there," said Warren. "I got a hunch it leads to the outside. Want to try it?"

Masters had already started down the passage. The prospect of escaping into the open spurred him on. But as they rounded a bend in the tunnel he stopped, spread his arms in a silent signal to Warren.

"Look," he cautioned. "There's somebody down there looking through the crack in the rock alongside that opening. That's where the light comes from."

"I forgot to mention it," Warren said softly. "When I was in the tunnel before I heard somebody scrambling over the rocks ahead of me in the dark. Figured it was the bird they were hunting for, but I didn't dare call."

"Who was hunting for?" asked Masters.

"Colonel McGuire," whispered Warren. "He was raising the devil because somebody escaped. Seemed worried."

Masters moved forward. There was light enough now to avoid loose stones. With the stealth of a puma moving up on a steer, the Eagle approached the man standing with his face pressed against a crack in a lava fold.

Suddenly he stiffened. His eyes narrowed, then flamed with hate. The face by the crack was that of Colonel McGuire.

Taking a quick silent step he moved

up behind the man and jabbed his forefinger into his back.

"Put 'em up, Colonel!" he ordered.

The man put up his hands. They trembled as he held them above his head.

"Turn around."

The man turned. His eyes blinked. His lips quivered as he stared at Masters.

"Beginning to shake already," Masters sneered. "You slimy rat. Search him, Phil."

Warren ran practiced fingers over the man's uniform, straightened and shook his head.

"Move out into the light more, you filthy Nazi," ordered Masters.

"I'm no Nazi," the man said huskily. "I'm—I'm—" He hesitated. "I'm an American. I'm Colonel McGuire."

"I know you're Colonel McGuire." Masters stopped. His eyes widened. "Say, what goes on here? Men don't grow whiskers that fast."

In the stronger light Masters saw that the man's face was covered with a stubble of beard, and remembered that when he had seen the colonel a few minutes before, the officer had been clean-shaven.

"An' look at his uniform!" Warren chimed in. "It's as dirty as if he'd been playin' tit-tat-toe in a flicker's nest."

"Are you really Colonel McGuire?" Masters asked.

"I—I think so," muttered the man. "It's so hard to remember. Something has gone wrong with my mind. I must be going crazy. Who are you?"

"We're friends," Masters said, as he took the man by the arm and led him to a rock. "Here, sit down."

The man smiled faintly. "They weren't nice to me. You are kind. You must be friends."

"Who?" asked Masters as he stooped in front of the man. He studied his eyes. They were dull, like the eyes of the others he had seen. "Try and remember, Colonel. It means a lot to your country—to America. Try hard."

The man shook his head. Tears came into his eyes.

"I've tried so hard. I'm sure I am Colonel McGuire. Where I am, I don't know. But it seems to me I was sent to Iceland. Maybe that was just one of these awful dreams." He stopped, buried his head in his arms.

Masters waited a moment. "Come on, Colonel," he said. "It'll come back. If you can't think of anything else, tell us about those dreams."

The officer in the muddied uniform raised his head.

"I DREAMED they brought a prisoner in one night," he said. "He appeared to be a Nazi. I questioned him. He offered to show me a spot on the map where his U-boat was hiding—"

"Yes—go on," Masters said.

"I don't know what happened," McGuire went on. "While he was making a mark on the map something was squirted into my face. Then the dream got worse. There were more men. They questioned me. I saw them writing. Captain Lawrence came in. Something had happened to him. He did everything they told him, opened our secret files and—oh, I can't remember everything they did."

"You're doing swell, Colonel," Masters said. "They put you in a cell and you escaped, didn't you? There was another man who called himself Colonel McGuire, wasn't there?"

The man looked up. "Yes. It was so confusing. It was like sitting outside my own body and watching myself issue orders. Everybody obeyed him. . . . I wanted to shout, to tell them he was a Nazi. But I couldn't. He ordered me to obey him. I tried not to, but something made me. You've helped—things I've been trying to remember are coming back to me."

"Can you tie that?" muttered Warren. "That guy got in here an' took the colonel's place. A perfect double for him if I ever saw one."

"Just a minute, Phil," Masters said.

"Colonel—pay close attention. Can you remember ever meeting somebody who looked like you? Try hard. Go 'way back. Were you ever in Germany?"

The man thought a moment. "I was military attaché in Berlin for five years," he said softly. He ran his dirty fingers through his hair. "It seems to me I have . . . Oh, now it is clear. Martin Kolburgh! Martin Kolburgh, the well known chemist. We were always being mistaken for each other. It was quite a joke. I have seen him lately, But I cannot remember where."

"Martin Kolburgh," Masters repeated. Suddenly he snapped his finger. "M-Eleven! Martin-K. M for Martin, and K is the eleventh letter in the alphabet. So our phony Colonel McGuire is M-Eleven!"

"Which is a clever surmise," a voice cracked out of the shadows. "Don't move. I have you covered. This time I will not bother with clever schemes. Three bullets will do the work better."

Masters moved slowly as he straightened. He knew who he would see when he turned.

"So, M-Eleven," he said after a moment, "you've got the upper hand again."

"And I'll keep it," snarled the Nazi. "It is fortunate I would not give up my search for the colonel. My hunt has added two more to my bag. Two clever Americans."

"You rat!" snarled Warren.

"Steady, Phil," cautioned Masters. He was stalling for time. His mind clicked into high speed as he looked for some way out of this dilemma.

"Too bad you men did not choose the stage," M-Eleven said, and grinned. "You are both good actors. Fooled me completely. However, I am past the stage of fooling or being fooled." The gun steadied in his hand. "Sorry you will not be here tomorrow to see my triumph. I had thought of using you two. But the *Fraulein* and her mother were correct. You are dangerous as long as you are alive."

His finger tightened on the trigger. Masters' muscles tensed as sudden death stared him in the face.

"Good-by, Masters." The Nazi's voice was cool, steady.

There was a scream, a flash. The shot echoed along the lava folds of the tunnel. Another cry, this time of pain. Then a curse as two bodies thrashed amongst the stones.

"Quick!" shouted Masters. "Grab that gun before he can shoot again. I'll get the colonel."

said after a quick examination of Colonel McGuire's chest. "He'll be all right as soon as we get the bleeding stopped. His weakness from hunger helped knock him out."

"What'll we do with this tramp?" demanded Warren, as he toed the unconscious form of M-11. "That wallop sort of makes up for the one he gave you. Only he tried to needle you afterwards."

"Phil!" cried Masters. "Phil, you're a genius!"

*John Masters, the American Eagle,  
Battles Side by Side With the Gallant  
Pilots of Conquered Lands Who Just  
Won't Stay Licked*

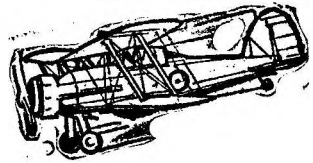

IN

## EXILED WINGS

*An Exciting Complete Book-Length Action Novel*

By **LIEUT. SCOTT MORGAN**

**PACKED WITH ZOOMING THRILLS**

**FEATURED IN THE NEXT ISSUE**

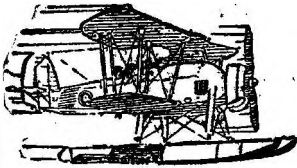

As Warren kicked the automatic out of the German's fist, Masters threw the battling Colonel McGuire to one side and caught M-11 alongside of the head with his fist. The big Hun suddenly relaxed, and lay with his arm flung across the bleeding chest of the colonel.

"Took it to save us," muttered Warren, as he snatched up the gun. "Ought to drill this mug right now."

"Only a superficial wound," Masters

"What have I done now?"

"Given me a swell idea," Masters cried, as he fished in his pocket for the hypodermic. "We'll turn the tables. We'll hang him on his own petard."

"Whatever that is," Warren said, as he watched Masters roll M-11 over and jab the needle into the back of his neck. "Giving him the needle, eh? Hope it's something better than distilled water."

Masters straightened. He threw the

needle against the rocks and grinned as it smashed into a thousand bits.

"How you feeling, now, Colonel?"

"Better." McGuire smiled. "The shock seemed to have cleared my mind."

The Nazi was stirring. He sat up and felt of his head.

"*Vos ist los,*" he murmured thickly.

"Not a thing, my friend," Masters said, as he booted the Hun with his foot. "Get up. Be quick about it."

The German scrambled to his feet and stood looking at Masters in dumb amazement.

"Now, Martin Kolburgh"—Masters spoke slowly and distinctly—"you are obeying orders, my orders. Understand?"

"*Ja wohl mein Herr.*"

His voice had grown dull, listless. The triumphant luster had faded from his eyes.

"You have a schedule of tomorrow's operations?" Masters demanded.

"Ja." The Nazi nodded.

"Hand it over," the Eagle ordered.

The Nazi opened his tunic, reached into a slit in the lining, and took out an envelope. Without a word he handed it over.

"I've seen everything now," Warren muttered.

"Sit down over there, and don't move," Masters commanded.

When M-11 had seated himself Masters opened the envelope and took out a sheet of paper. His brows knit into a frown as he read the typewritten words.

"Of all the dastardly schemes," he finally exclaimed, "this takes the cake! I was right, Phil. It was to be mutiny—worse than that. He had it rigged so this detachment would help a flock of Jerries land here tomorrow morning, and not only that, they were going to help the Nazis fight the British contingent! Poor doped guys were to keep yelling they wanted to go home, didn't want to fight the Nazis."

"Wouldn't that pop the lid off back home?" Warren's voice was tense,

anxious. "If it's set for tomorrow, how are we going to stop them?"

Masters glanced from the schedule to M-11.

"He was going to use us. Now the tables are turned. We'll use him."

"But the men!" exclaimed Warren. "They're still under the influence of this drug."

**M**ASTERS whirled. He grabbed M-11 by the front of his tunic and yanked him to his feet.

"Get that brain of yours working, Martin Kolburgh. Is there anything that will snap these men out of it? How long will that doping you've done to them last?"

The German shook his head stupidly.

"Come on—snap out of it," snarled Masters. "We've got work to do. Think! That's an order. You've got to tell me."

"Some emotion will do it," mumbled the German. "It's effect does not last more than a week. . . . Stop! It makes me dizzy to think—but I must follow your orders."

"Some emotion!" cried Masters. "God only knows there'll be emotion enough back home if this thing goes through. The appeasers will be weeping on each other's shoulders sobbing 'I told you so,' over every mike in the country. . . . Mike! Say that gives me an idea."

"What now?" demanded Warren.

"Let me think," Masters said. "Hey you, Kolburgh. You carry the colonel and lead us out of here. Come on, I'm giving orders. We're going back to the office, and you're writing a few orders."

When they reached the colonel's office, Masters ordered M-11 to issue a command that from then on officers and men were to obey the Eagle's commands. Then handing the wounded colonel over to the M.O., who seemed to have no recollection of having stuck a needle into his neck, Masters dropped into the chair behind the desk



and began to write orders of his own. As he wrote them he pushed them over for M-11 to sign.

"This is fun," he said to Warren. "Something must be squirming inside this Hun. He's doing just what he intended for us to do."

Suddenly he swung around to face the German.

"Where are the two women?" he demanded.

"In Reykjavik."

"Doing what?"

The German shrugged.

"See that they're rounded up," Masters said, turning to Warren. "And fly this stuff back at once. I'll be needing it in a few hours."

Warren shook his head. "Sure is a screwy scheme he figured out. Why, the destroyers and men from Reykjavik would come up here and there'd be the devil of a fight."

"But the damage would be done," said Masters. "Of course the plan would fail from a military angle. But the news would get out. Think of what would happen to the morale of the boys back home! Think of what would happen in England when they learned American troops had revolted and sided in with Nazis in the battle. Be some battle, too. According to this schedule there are four transports, twenty U-boats and a flock of Jerry planes scheduled to appear on the scene at six-thirty tomorrow morning. Now get going. Give half of these orders to General Tremaine. Let him handle the naval end of it. You take care of the R.A.F. angle, then get back here with the stuff."

"Will you be all right here alone with this mob of drugged men?" asked Warren, as he took the sheaf of orders. "Can't see how he managed to get them all under its influence."

"Pressure tank with a nozzle," said Masters. "That's the way I picture it. Be easy to go from tent to hut, slip the nozzle through, and give them a dose of gas. Dressed in the colonel's uniform M-Eleven could get the sen-

tries first. The rest would be easy."

"What'll they think of next!" growled Warren. "Is that the way you pulled it, Martin Kolburgh?"

"Ja." The Nazi nodded.

"Knew Colonel McGuire, your double, was up here so you came ashore one night from the U-Sixty-three and deliberately allowed yourself to be taken prisoner by the colonel's men, didn't you?" Masters barked.

The German frowned. "Ja, mein Herr."

JOHN MASTERS turned to Warren. "I think I see one of those Reykjavik taxis over there by the tank park. More than likely the same bus that brought you here. Better grab it and get going. Stop at the first flying field and get a plane. Here's an order to take care of that. Now scramble. His nibs and I have work to do."

"Touching," Warren said over his shoulder. "Poor M-Eleven issuing orders to blast his *Fuehrer's* men right out of the water. Okay—I'm off in a gale of lava dust."

"Be seeing you," Masters said. "Don't stop to eat."

When Phil was gone Masters turned to the Hun. "Where do you mix this dutranamide with M-Seventy-five?"

"In there, *mein Herr*," the German said softly.

"Come along then," Masters ordered. "*Schnell!*"

The Nazi leaped to his feet at the Eagle's order.

"You go through the door first," snapped Masters. "I pretty near did that once too often."

They stepped through into what once had been Colonel McGuire's quarters. Now it looked like a laboratory. The thing holding Masters' interest was a metal contraption in the far corner. On a shelf over it were at least a dozen of the gleaming metal flasks. By their side, heaped in a pyramid, were a pile of three-cornered green bottles.

"M-Eleven," Masters, said turning

on the Nazi, "what is your M-seventy-five formula?"

The German shook his head. "It is complicated. It's principal ingredient is Cyclocoradine."

"Complete anesthesia of the brain and nerve centers," Masters growled. "And you were going to fix me up for good, you swine."

The Nazi shrugged his shoulders. A silly grin played across his face.

"Smash that apparatus!" roared Masters. "Tear it apart with your bare hands. You built it. You destroy it. That's an order. Get moving. *Schnell!*"

The German hesitated. There seemed to be some inward struggle going on in his brain. He looked at Masters, and his hand trembled as he brushed it across his expressionless face.

"Go on—tear it apart!"

Masters grabbed the Nazi and flung him toward the twisting tubes used to mix dutranamide with the deadly M-75 formula—the thing that had brewed the dangerous nectar of forgetfulness.

Whimpering, the Hun started to rip the machine apart.

"It's dry," said Masters. "You milked it dry. Had a hard time getting dutranamide from Professor von Gelsen, didn't you? Had to hurry. Couldn't wait until you had a full supply."

Tears streamed down the German's cheeks as he stepped back. Despite the drug that numbed his brain, putting him in the power of this strange American, he knew he had done something wrong. The picture was jumbled in his brain. It was going to work out the way he had planned it all.

"Okay," Masters said, pointing toward the door. "It's about time we got in touch with the battery commanders along shore. You'll give them their orders, too."

"Ja, mein Herr," M-11 said most humbly.

## CHAPTER X

### *The Ramparts We Watch*



HE sun had kissed the horizon and was starting its upward swing when an assembly sounded through the startled encampment. Sleepy-eyed, dull-faced men stumbled along the company streets, directed by officers and sergeants toward a shelf of rock just north of the tank park.

Waiting on the ledge, with M-11 standing beside him, stood the Eagle. On a box just in front of him lay a hand microphone, to which Phil Warren was attaching wires.

"She's all set, John," Warren said.

He got to his feet and looked out over the men who stood below, dumbly waiting for orders. They had been told that an important command would be issued that morning. Many of them still had a faint recollection of their colonel promising them a speedy return to the States. Perhaps this was it.

"We've got to get moving," Masters muttered.

He glanced at his wrist-watch, then looked out across the tank park. Off to the west he could see a pair of Hurricanes standing on the narrow road across the jumbled lava field. It was the only place they could possibly be put down. Behind them was the transport plane in which the equipment he ordered had been sent.

General Tremaine's at the mike on the other end," Warren said. "He's got them assembled in the square by the monument."

"How about the R-Forty-seven dames?" Masters asked.

Warren shook his head. "Can't locate them."

"Feel better if they were out of the way." Masters looked to either side of him. Two hastily rigged poles stood at each end of the ledge. "Okay, let's get going. Looks as if they're all

here. I've got the switches open to the battery commanders. Come on, take your bow, Martin Kolburgh. Don't forget your orders."

The German, still dressed in the uniform of an American colonel, stepped forward, a perfect double for Colonel McGuire who had been flown to the base hospital in Reykjavik an hour before.

The Nazi hesitated. Masters held the mike to his lips.

"Go on!" he commanded.

"Men," M-11 said, "for the next few hours you are to obey the orders of the man standing at my side. Under his leadership you will crush the *Fuehrer's* men who are already approaching the shores placed in your care."

"When do we go home?" somebody shouted from the front ranks. "You promised us. You said we didn't have to stay and fight the Nazis."

Masters grabbed the mike from in front of M-11. Warren reached out and pulled the Hun back.

"Americans!" Masters shouted. "You're Americans, all of you. You're here to fight the Nazis, to help keep the sea lanes open so that precious supplies can get through to England. Think hard! Get your minds working. You know you hate Hitler and everything he stands for. You've been duped by a slinking Fifth Columnist. He drugged you, deadened your brains. But try to recall the country you came from, the loved ones who wait back there, loved ones who have faith you won't let them down. No Yankee will ever buckle under to a bloody dictator! It's not our way. We fought for freedom once. We'll do it again! Try to think—think of what the word 'American' means! Listen—perhaps this will help you."

Masters wiped a stream of perspiration from his forehead.

"Okay, General Tremaine," he shouted. "Let's have it."

Four loudspeakers placed in rock fissures behind him began to hiss.

The American Eagle looked down at the men standing stolid before him, their eyes dulled by the terrible drug.

Then the loudspeakers blared forth with the opening bars of the "Star Spangled Banner." Back in Reykjavik every musician, civilian or military, had been assembled in the square. A British captain, standing on the steps of the statue of a Viking warrior staring out to sea, led the massed bands in the stirring strain.

The Eagle watched the effect on the men standing before him. Here and there an eye brightened, a back straightened.

"It's working!" Phil shouted in his ear. "Look—some of them are snapping to attention already."

As the music came to the lines, "O'er the ramparts we watched were so gallantly streaming," Masters jerked his head in a signal to the men at the poles. Two American flags unfurled, straightened, their red and white bars pointing challengingly out to the fjord.

**M**ASTERS pressed a switch. The music stopped for a moment.

"We're watching the ramparts, men!" he shouted. "We'll keep the flag flying there. Come on now—sing! Sing so loud the Huns out there on the fjord can hear you. Let 'em know they'll never put a swastika up there. Now, all together!"

He released the switch. The loudspeakers picked up the refrain and hurled it out over the heads of the assembled men.

With Masters and Warren leading, helped by the officers who were following orders, the men began to sing, a group here, another there, scattered at first, then mingling until a mighty chorus reverberated over the lava beds.

A rocket hissed into the morning air and broke over the waters of Breidifjord. It broke in a red glare and showered stars in a glistening spray.

Masters pointed toward the flags waving proudly over his head.

A gun boomed. The sound thundered back and forth along the rocky coast.

Now the soldiers were all singing. Eyes glowed with pride as they watched the waving flags. Mouths opened wide, pouring the song they loved into cool crisp air of an Iceland dawn.

The music died away.

A murmur rumbled through the mass of men.

Masters stepped to the edge of the shelf of rock and held up his hand.

"Who are you?" He thundered the question over their heads.

"Americans!"

Loose lava cascaded down the hill behind him as their voices blasted the air.

"Do you hate Hitler?"

"Yes!" they chorused.

"Are you ready to guard the ramparts?"

"Yes—yes!" they cried.

"And give your all to free the world?"

"We're ready. You lead us."

"They're coming!" Masters pointed out over the fjord. "Hear their guns? Your companions are already fighting for democracy out there?"

"What are we waiting for?" cried a voice from the front ranks, the same voice which a few moments before had asked about going home.

"Your officers have their orders!" shouted Masters. "Obey them. Keep the flags flying."

On a cue from the Eagle the bands in Reykjavik began to play again. With the song ringing in their ears the men hurried to their stations, ready, eager to strike their first blow to insure the freedom of the democracy they loved so well.

And mingling with the music was the rumble and roar of guns out of the fjord.

The shore batteries were already in action. . . .

The Eagle poured his Hurricane into the dawn skies. Behind him flew Phil Warren. As they circled over the encampment, Masters saw the tanks already trundling their way toward the beach. Machine-gun crews were taking their stations among the rocks. Anti-aircraft batteries were unlimbering, and shells laid in orderly rows were ready to be fed to waiting breeches.

"Hey, John!" Warren shouted into his phones. "There's that taxi again."

Masters kicked rudder. He saw the little gray car bouncing over the rough road. It was heading toward the spot where the transport waited.

"WE'LL tend to these other guys," Masters shouted back. "See them coming in over the fjord? Junkers Ju-Nineties. Troop carriers. Got to nail them over the fjord, so they can't drop chutes."

"Let's get going then," Warren answered. "I want this over with. I'm hungry. Haven't had a square meal since we hit this place. . . . Whoops, here come the British!"

Masters saw them pouring through the dawn as he tangled with the first four-motored giant. He was up under it, pouring slugs from his eight Brownings into the bottom of the Junkers. He saw it stagger. Then, like a gigantic bird, it began to molt parachutes. They came pouring out of the hatches, tumbling end over end until the chutes cracked open. A few of them tangled, and instead of opening plummeted straight for the cold waters of the fjord.

The formation of Junkers scattered. They had been told in Norway the thing was going to be a push-over. Much easier than Crete. For here, the Americans were supposed to assist them.

As Masters caught another Junkers in his web of tracer, he saw destroyers and patrol boats mingling with Yankee mosquito craft that was zigzagging over the fjord dropping depth



bombs and ash cans all over the place. The water boiled with explosions. Oily patches appeared, spread in great iridescent patches.

Further out, a couple of British cruisers and an American battleship were pouring salvos into the great troop-laden transports. One had already been run on the rocks, and was now a great twisted hulk of flame. Gray-clad men, the few survivors, swam and waded ashore where they lined up with hands held high while they whimpered 'Kamarad'!"

to see a pair of Junkers bracketed by a Yankee anti-aircraft battery along the shore. The burst crackled around them, then the second salvo caught hold, ripping away the wings of the Junkers, sending them twisting toward the beach, battered hulks from which parachutists fought to escape.

Then, for a wild moment, slugs whipped around the American Eagle's Hurricane. They flailed the air with lethal death while he banked desperately to evade the clustering burst. Cutting into a breath-taking zoom, he

---

AMBROSE HOOLEY AND  
MULEY SPINK TRY TO  
WIN THE GUERRE WITH  
UNCLE WILLIE'S KOOTY  
KRUSHER

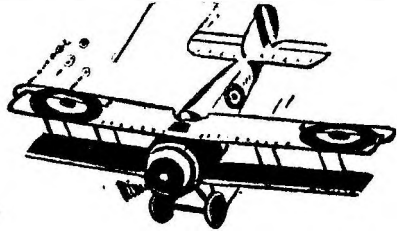

IN

## DAWN PATROL WAGON

*An Uproarious Air Action Howler*

By **JOE ARCHIBALD**

IT PACKS A LAUGH — AND A THRILL!

*Coming in the Next Issue*

---

Diving on a Junkers, Masters looked down over the tilted wings and smiled as he saw the Star Spangled Banner and the Union Jack fighting side by side. He saw a Nazi U-boat pop to the surface, falter, then hang in the water with its stern in the air. A moment later its conning tower was ripped away by an explosion. At that split second the Eagle threw a short squirt of blazing tracer into the rudder of the Nazi plane and sent it hurtling dead into the middle of the boiling wreckage.

Straightening out, he was in time

came out of a half-roll in time to see a pair of planes pouring hot stuff into the bewildered Junkers.

"Yanks!" he shouted as he caught sight of the star insignia gleaming from their wings. "They've got the American planes into action."

**B**EFORE he could straighten out the two American planes blasted the big troop plane into a mass of flaming wreckage. The fuselage broke in half, spilling Nazi parachute troops into the dawn air. They fell, a tangling mass, splashing into the water

like canvasbacks coming in at dusk.

"Ride 'em cowboys!" the Eagle shouted into his flap mike. "Give them the taste of Yankee lead they've been asking for!"

The Eagle was proud, flying up there along the high ramparts with his own brood. Nazidom that dawn was getting a preview of what to expect if it goaded the American Eagle too far. They waved to him and then went on with their grim work.

The Junkers were scattered now. Only a couple of them remained in the air. One was trying to take a sneak into the scattered clouds drifting in from the north. Masters kicked rudder, determined that no Nazi would return to give the *Fuehrer* a report of the morning's debacle.

"John! John!" Warren's voice came through the phones, pitched high with excitement. "The dames! The two R-Forty-sevens! They swiped our transport and are heading out to sea. I'm sure I saw them drag M-Eleven into the plane with them. Straight ahead! That ship heading for the clouds."

With a curse Masters yanked the knob of his emergency boost. The Hurricane leaped forward as if stung by a thousand needles. He held it out as long as he dared, then released it before his motor seized.

But that brief interval of acceleration was enough to put him on the tail of the escaping Douglas. Already a burst of fire was being poured at him as he flashed over the weaving ship and then dived. At the controls he could see the younger of the R-47s. She looked up at him, shook her fist, then tried to dive into the cloud.

"No you don't!" shouted Masters.

His thumb hit the button. His Brownings spewed lead into the metal skin of the big ship. In the port blister he caught a glimpse of a figure falling over his gun. The gun had been muted by death.

"M-Eleven," he muttered. "That's the finish of that guy. Never knew

what he was doing after I gave him a dose of his own medicine."

Again his thumb came down on the button. He could feel the impact of his blazing Brownings even in the cockpit. Chunks of metal fluttered away from the Douglas as it disappeared in the cloud, tail high.

Following through, Masters poured out of the cloud in time to see R-47 the younger tooling the big ship toward the heaving sea at a desperate pace.

"A sub!" he snarled. "They're making for the sub."

His guns blazed again. But the big crate went on, skidded over the waves in a belly landing close to the U-boat and came to rest tail still high in the air.

A second later two figures emerged from the wreck and struck out for the U-boat.

"Can't fire on them while they're in the water," he snarled. "But nothing'll stop me from taking a crack at the Nazi's on the U-boat."

But when he pressed the button his guns stuttered half-heartedly and stopped. His belts had been emptied in the terrific battle over the fjord. There was no way of stopping young R-47 and her mother.

He circled as a small boat put out from the sub and picked the two women up. There was no use calling the destroyers. The rescue would be made and the German craft submerged and on its way before depth charges could be brought into play.

**T**URNING back with a shrug, he headed for the fjord. Even at a distance he could see the flame from wrecked ships, the oil smears where U-boat after U-boat had gone to the bottom. Of the three transports only one was afloat. It listed badly as the survivors were being taken on board a destroyer.

"A nice morning's bag," he mumbled, and grinned. "This will be something to make Hitler think twice be-

fore he starts meddling with American troops again."

He came roaring up to the head of the fjord. As he banked, a cloud which had obscured the sun for a moment, split. Through the opening a shaft of light gleamed, falling like a huge

spotlight on the two flags waving so proudly on the ledge. His heart beat faster. A broad smile crossed his face. He stiffened and raised his hand in salute.

"'O'er the ramparts we watch,'" he murmured.

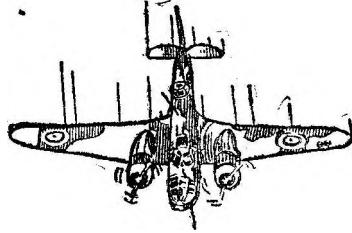

RIP-ROARING BATTLE ACTION FROM START TO FINISH IN

## EXILED WINGS

By **LIEUT. SCOTT MORGAN**

NEXT ISSUE'S COMPLETE BOOK-LENGTH SKY NOVEL

**"I wish he were a well-groomed lad—  
He really ought to read this ad!  
It says for comfort, thrift and speed  
These Thin Gillettes are what men need!"**

Precision made to fit  
your Gillette Razor  
exactly

Produced By The  
Maker Of The Famous  
Gillette Blue Blade

**4 for 10c**  
8 for 19c

**Save Extra Money! Get The Big New Economy Package, 12 For 27c**



## LIQUID-COOLED MOTORS

**N**OW, folks, after having given you some dope on air-cooled engines, it is only fair to the liquid-cooled motors that they have their day in court—which is today.

Suppose we start it by making a statement which we could have made in the last lesson, since it is true of all gas engines. It sounds like a paradox, since we told you how marvelously efficient airplane engines were as compared with other gas engines. We said that while it takes ten to fifteen pounds of motor to produce a

of them letting it escape and the fourth only conveying its share to the engine.

But that's not the whole trouble. We have two problems added to our troubles, how to get rid of the heat from the exhaust, and how to get rid of the heat in the cylinders, which that wasted energy created.

The first is reasonably simple, we merely have to build an exhaust manifold of such heat-resisting metal as will work without burning out, and then conduct the exhaust heat safely away from the ship. But the manifold has weight which our poor little 25% of energy has to lug along with it, thus using up some of its precious little energy for that.

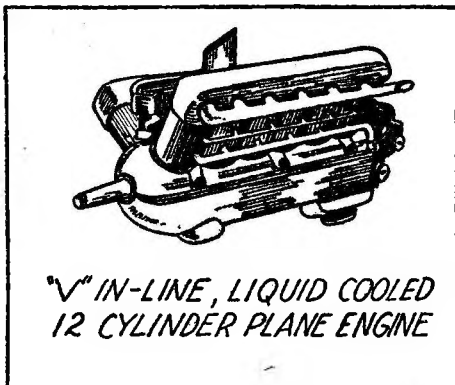

*"V" IN-LINE, LIQUID COOLED  
12 CYLINDER PLANE ENGINE*

### *This Causes the Headaches*

And then comes the big problem—how to get rid of that 28% of heat which went into our cylinder metal. That's the big job, a bigger one than trying to get full use of the useful energy.

This job is the one that causes the headaches, and no matter how we tackle it, we have to add more work for our 25% effective energy to do, by adding weight to the energy. This added weight is either in the form of fins on the air-cooled engines, or the liquid radiator system on the liquid-cooled jobs. This added weight, which adds nothing to our flying purpose, merely deducts its added quota from the 25% efficiency which we have captured. So, you see, we get precious little for our gallon of gas, and it's no wonder that we are looking for more efficient means of powering a ship.

But what we're focusing on today is the liquid cooling system.

Liquid-cooled motors are usually in line, or Vee-in-line as to design. There will probably be two banks of four or six cylinders operating at a Vee angle to a common crankshaft.

Thus the first cylinder on the right bank and the first one on the left bank will be attached to the same crankpin, and so on down the line. (We have to repeat here that there are a few radial, liquid-cooled motors.)

### *Drawbacks of Air Cooling*

Now we have to examine some of the drawbacks of air-cooled motors in order to understand why we use liquids. That is because the air-cooling system is simpler and cheaper, and we would use it alto-

horsepower in an auto, the airplane engine was so efficient that it could produce a unit of horsepower with only a pound and one-half of weight.

But—and this ought to surprise somebody—the finest airplane engine made only converts one-fourth of the energy produced into power on the propeller. Three-quarters of the heat produced by a pound or a gallon of gasoline is wasted!

### *Here's What Happens*

That's the record of the finest gas engine made! Here are the figures, showing what happens to the energy produced by a gallon of gas when burned in an airplane engine:

Percentage of energy supplied to engine used in turning the propeller—25%.

Percentage of energy consumed in heating cylinder walls and cylinder head—28%.

Percentage of energy escaping with exhaust—47%.

There you go, folks, three-quarters of your gas bill wasted. It's like pouring your gas into a tank with four holes in it, three

gether if it weren't for these drawbacks. And they are several.

In the first place, air cooling is all right for small motors, up to a few hundred horsepower, but above that the system is barely adequate to keep the engine cool enough to function.

Another serious trouble in a high-powered motor is that the air current hits the front side of a cylinder and cools it, but leaves the back side of the cylinder hotter because it doesn't get the draft of air the front gets. This difference in heat on two sides of a cylinder tends to warp it, and consequently its bore won't stay round, and you can have trouble with your pistons fitting properly without leakage.

Twenty years ago they tried to solve this problem by rotating the whole engine, as in the case of the "Gnome" rotary motor, of World War fame. But a rotating motor offered tremendous head resistance, and was dropped altogether.

#### Uniform Temperature

Now none of these problems are present in the case of liquid cooling, because when we can completely encircle a cylinder with a liquid which is in circulation, all cylinders, and all parts of each cylinder will be of uniform temperature. Furthermore, we are not restricted as to cooling surface to just such air as will encircle a cylinder, but can expose the liquid by way of radiator combing to as much air as we need to keep the engine at a predetermined temperature.

There are two ways of exposing this liquid to the air so that the air will carry away the heat. One is by way of a regular radiator honeycomb, such as we see in

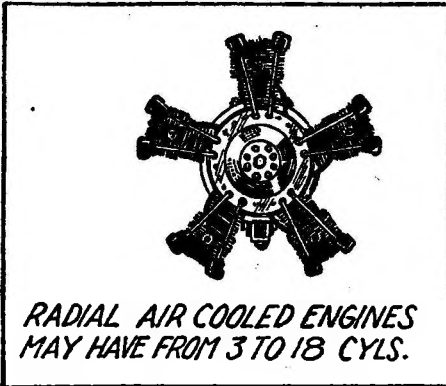

autos, and the other is by way of double-skinned wing and other surfaces. We can, and sometimes do, use both.

Of course, a honeycomb radiator offers a little head resistance, but not as much as the front of a radial motor. But in cases where speed counts, we can use such devices as double skins in the leading edges of the wings, or for that matter, we can use the whole wing surface as a radiator, and completely eliminate any head resistance.

In many of the ships entered in the Schneider Cup races the entire radiator cooling system was merely double-skinned wings, and the cooling liquid from the motor went directly to the wings and with the aid of pumps, was circulated through the whole wing surface before being returned to the motor; the wing surfaces being made of two metal sheets with thin space between them.

To give you some idea of how much energy is wasted by this necessary throwing away of heat, in the later races, when ships were run too long at full speed the entire wing surfaces were not large enough to keep the water cool enough and the engines would overheat!

This system of cooling the liquid in the wings has been used to a small extent in ships of more practical purposes, but it usu-

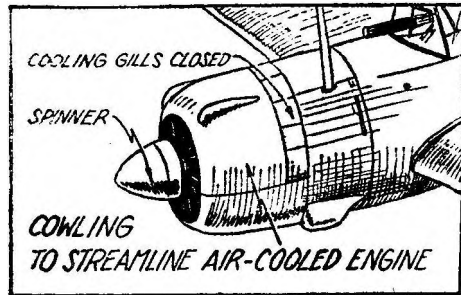

ally complicates matters too much, due to the fact that the ship itself has to be built and designed for that purpose, and it hasn't yet been made a practical system.

#### Ethyl-Glycol

For this reason, the trend has been to try to find cooling liquids which work effectively with less radiator surface exposed. Along these lines, ethyl-glycol has come into use.

To understand its value, you must first realize a fact which is not entirely clear to everybody. That is, that, strangely enough, the hotter a radiator is, the more heat it will give off to the air. This is due to a law of radiation to the effect that it is the *difference* in temperature between two objects which controls the speed with which heat will pass from one to the other.

According to this law, then, if we had a radiator in which the liquid was 400 degrees, heat would pass from it to the air at a much faster rate than if its temperature were only 200 degrees. Or to put it another way, if we had a certain amount of heat to get rid of, a smaller radiator surface at 400 degrees would give off the same heat as one twice its size at 200 degrees.

Now, don't get lost in the middle of this trail.

Water boils at 212 degrees. Above that it turns to steam.

A liquid called ethyl-glycol won't boil until it reaches more than 400 degrees. So



—if we put ethyl-glycol in our radiator system we need only half the space to carry off the required amount of heat from the motor that we would need with water. Thus, less head resistance—or more speed.

I think you students ought to study this explanation, because it is the simplest I've ever seen printed, even if I have to print it myself. So, chemical coolers are better not because they are cooler than water, but because they are hotter!

Actually, there are probably, or could be created, liquids which wouldn't boil at any temperature an engine could generate, but the heat of the liquid must be limited by the fact that the motor itself could not function best at such high temperatures.

*The Useless 28%*

Now, all this hullabaloo is caused by the fact that we have had to get rid of an ut-

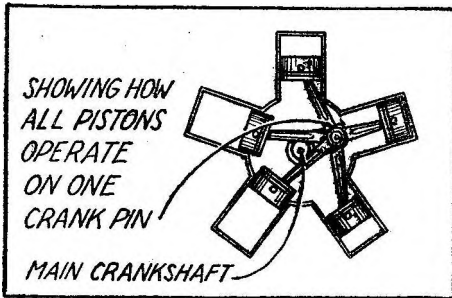

terly useless 28% of our fuel, and that the job is a considerable one. The task has added a lot of weight to our engine in the way of radiators, piping, outside walls and water jackets, water pumps, temperature gauges, etc., as well as added head resistance.

All this, plus the weight and resistance of a metal exhaust manifold, which you will remember we had to use to get rid of the other 47% of wasted energy, adds up to a lot of weight our 25% of gas has to tote along just because we haven't found any way to convert that other 75% of fuel into energy.

But that's not all. Out of a hundred gallons of gas weighing something less than 800 pounds, we are getting useful power out of only 200 pounds of it, with 600 pounds of it only going along for the ride and therefore being only some more dead weight the working fuel has to carry along.

But you're not through imposing on that single gallon of gas out of every four, even yet.

A certain amount of the heat generated in the cylinder heats the pistons, and while some of this heat passes on to the cylinder walls and is carried off as mentioned above, more of it, plus heat generated by friction of the bearings, goes to heat up the lubricating oil.

And lubricating oil will break down when it gets too hot. So in some high-powered motors we've got still more heat to get rid of.

In such cases we're very likely to have a special radiator and pump just to cool the oil. And that offers considerably more weight and resistance.

By now you should see that it amounts to a lot more than just the toss of a coin whether you have air-cooled or liquid-cooled motors in your ship.

You should be fervently thanking your stars that you only have to fly the ships, that you only have to run the motors, not design them.

—BRUCE McALESTER.

COMING NEXT ISSUE

# HIGH ALTITUDE EQUIPMENT

*Another Interesting Lesson in The L. E. A. Flying Course*

Air Fiction and Features by Your Favorite Writers  
in Our Companion Magazines

**RAF ACES  
SKY FIGHTERS  
and AIR WAR**

**NOW ON SALE — EACH 10c AT ALL STANDS**

# Wings of Sand

By ROBERT SIDNEY BOWEN

Author of "Unofficial," "Memory Aces," etc.



Frantically, Grey tried to leap into the idling plane

*Barry Grey, Yank Pilot with the R.A.F., Flies Over the Blazing Sahara Desert in Search of a Mad Bandit Who Savagely Tortures His Victims!*

**F**LYING Officer Barry Grey squatted in the shade of a scraggly palm and stared moodily out past the line of Royal Air Force planes at the Sudan end of the mighty Sahara Desert. The

rolling white wastes glistened and shimmered in the scorching rays of the sun, heat waves swaying this way and that like a ballet mirage.

For several minutes Grey stared at the great expanse of shimmering

white hell, and then slowly placed his thumb to his nose and waggled the extended four fingers.

"Nuts to you," he grunted. "This time tomorrow I'll have seen the last of you—although I would have liked to see the end of the Mad Mullah before I left."

In twenty-four hours Grey would be well on his way to the Alexandria base of Squadron 10, R. A. F., where he was to board a transport for London. Upon reaching London, he would receive his honorable discharge from the Royal Air Force and then proceed home to America to join the flying school of the greatest peacetime armament program the United States had ever seen.

With the collapse of the French Government, while England was girding herself to carry on the war and French colonial possessions were grimly determined to fight on, Grey knew his greater duty lay in returning to the States to do his bit for American preparedness.

He looked up as a shadow fell across the hard ground before him. Munson, a flight corporal, was standing at rigid attention.

"Relax, Corporal," Grey said, smiling. "What is it?"

"Commander Barnes is taking the patrol out in thirty minutes, sir," Munson reported. "He asks that you report for final instructions with the other pilots in ten minutes. And, sir—I'd like your permission to say something."

"Fire away," Grey granted, getting lazily to his feet.

"It's this, sir," the corporal began. "The mechanics and me will be sorry to see you leave tomorrow, sir. You've—you've been a bit of all right with us. What with your jokes and tricks, sir."

"Think nothing of it, Munson," said Grey, really touched by this show of emotion. "I never was much on military rank. A man's a man to me, private or general. Shake hands?"

Delighted, the corporal stiffly held out his hand. Grey easily brought his right hand from his pocket and clasped the other's palm. Something vibrated sharply—like a buzzing rattlesnake—and Munson jerked his jarred hand free and leaped back in alarm.

Grey laughed at his dismay and held up a round, metal disk.

"Just a glad-hand buzzer, Corporal," he explained. "A sort of friendly razzberry. Here, you take it to remember me by. Give your mess-mates the glad hand. But if you ever meet up with Hitler, don't use it. Give him a hot-foot instead."

"No, sir. Thank you, sir," said Munson, saluting and accepting the little joke gadget to examine it curiously. "Ain't you the one though, Lieutenant!"

**A**FTER the chuckling corporal left, Grey stared once more out across the burning desert. Somewhere out there in those thousands of square miles of arid wasteland was a mad Arab. A mad cutthroat Mohammedan who was being financed by the Nazis to give the British Government as much trouble as possible here south of the Mediterranean.

Abu Mah Dhow was a tribal chieftain, a mullah, who raided every unguarded outpost with his ever increasing hordes, who plundered every unescorted caravan, and laid waste peaceful native tent villages. He poisoned Bedouin waterholes, incited every form of mutiny he could, and of late had been successfully attacking small troop detachments.

Wherever he struck, he completely ravaged things, killing everything that lived and carrying off men captives to give to his fiendish desert women for torture. The Mad Mullah was becoming such a sharp thorn in the side of the Anglo-Egyptian administration of the Sudan, traveling with such speed with his racing camels to make raids where armored

car units never expected him, that the flight of Squadron 10 planes had been sent from Alexandria to patrol the lower Sudan and spot the whereabouts of the madman.

A solid month of daily patrols far out over the desert had totaled up to a grand crop of wasted gas and oil and several men. Spies had brought back the unpleasant information of what had happened to British officers captured by the Mad Mullah. A slow, horrible death at the hands of the wild women such as had been the lot of more than one poor devil in the French Foreign Legion.

For that reason every member of the flight was given a small vial of liquid when he went out on patrol. If, for any reason, he was forced down and was captured, he had only to drink the contents of the vial and stop worrying about the atrocities of tribal women. For, in three minutes, he would be dead.

"Just one more patrol," Grey muttered, "and then to blazes with the Mad Mullah as far as I'm concerned."

With a somewhat regretful nod for emphasis, he pulled a cigarette from his pocket with one hand and fished a one-inch, rimless magnifying glass out with the other. Holding the glass to focus the rays of the sun on the tip of his cigarette, he had a thread of smoke curling upward in practically nothing flat. Putting the glass away, he stuck the roll of tobacco between his lips and went puffing off to Squadron Leader Barnes' tent.

The seven other officers of the flight were already there. A couple of them nodded faintly as he entered, looking a bit fearfully at him. Grey grinned inwardly as he returned the greetings and strode forward to join in the examination of the huge map spread out on the table. Every one of his fellow officers had good reason to be suspicious of the American tricks Grey was constantly playing on them.

They were fine fellows, but Brit-

ishers were a bit stiff about harmless little jokes such as finding metal cockroaches in their soup, or fake ink blots on their full-dress uniform jackets, and things like that. As for exploding matches, cigars, or cigarettes—there wasn't a pilot in the group who would have accepted a smoke or a light from the irrepressible Grey on a bet.

"Well, now that you chaps are all here," Squadron Leader Barnes grunted as Grey joined them, "I'll map out the patrol area."

Barnes put his finger on a section of the map, his nail touching a red dot. From this dot eight lines were drawn out, fan-shape, on the map. Each line represented a distance of two hundred and fifty miles into the desert, the distance from one fan tip to the other being about a hundred and fifty miles. Thus, the wedge-shaped segment indicated thousands of square miles in area.

"Native spies report," Barnes went on, "that the Mad Mullah is operating near the Fada Oasis. So today, we'll patrol a good hundred miles on all sides of Fada and see if we can't spot some of the blighter's camel men. As usual, you will each select one of these lines as your patrol course, and fly compass along it accordingly. Cruising speed will be one hundred and seventy. If you sight any camel riders or horsemen on the way, mark their position on your maps, and the direction they are headed. Then report back here at top speed and forward your information to the Armored Car Units. Remember, report back and don't waste time firing on them."

**B**ARNES paused again and swept the group with a meaning look. Everybody nodded, and everybody knew the thought in their commander's brain. Just two weeks ago one of the pilots had spotted a dozen camel men racing across the sands, and had dived down and wiped out

the lot. Later, when an investigation proved the camel riders to have been a small detachment from the Egyptian Camel Corps, it had been most embarrassing.

"And now," the squadron leader continued, "when you reach the end of your patrol, the four on the right will turn left, and the four on the left will turn right. We'll meet in the middle and count noses. If anybody is missing, we'll all patrol back over his route. Well, I guess—"

At that moment an orderly came dashing out of the wireless tent and raced across the sand to Barnes.

"Just received it, sir!" he panted, and handed the senior officer a slip of paper.

Barnes read it. His jaw muscles tightened and a small patch of white appeared in each tanned cheek.

"The native spies' reports were correct," he said presently in a tight voice. "A stalled armored car was attacked near Fada last night. The entire crew was killed."

Silence settled heavily in the tent for a moment; for every pilot knew just what Barnes had meant by his simple statement:

"The entire crew was killed."

They were dead now, but what torture they had suffered before merciful death had come to them!

"Well, let's get on with it, chaps," Barnes finally broke the silence. "We'll meet at three thousand over the field and then be on our separate ways. One minute, Grey. I'd like to speak to you personally."

The other pilots glanced curiously at Grey. The American grinned at their perspiring faces and slipped a cigarette from a special package. Placing it between his lips he flicked a match head with his thumbnail and lighted it. Drawing the smoke once through the roll of tobacco to get it burning smoothly, he carelessly placed the cigarette on an ash tray on the table.

"Okay, Skipper," he said. "But if

it isn't a bawling out, why not let the gang listen. I don't mind."

The squadron leader hesitated.

"All right," he said slowly, fingering the wireless dispatch in his hands. "You can be excused from this patrol if you wish. You're leaving us tomorrow, and there may be some things you want to attend to. I can call your relief pilot to take—"

"Thanks, Skipper," Grey replied quietly as Barnes broke off, "but there's still twenty-four hours of my active service to go. I won't shirk it, and I'm darned sorry I have to leave before we nab the Mad Mullah. Maybe we'll get him today, fellows. There is as much chance of that as there is of a snowstorm here in the desert, isn't there?"

Even as he finished speaking, the air in the hot tent was filled with swirling, drifting, falling white flakes—a miniature snowstorm in truth. All of the fliers stared in bewilderment, and Grey began laughing. With one accord they all looked from him to the half-consumed cigarette which was smoldering away on the table, a white plume of smoke ascending innocently ceilingward. Then they all laughed uncertainly.

"Another one of your balmy American jokes, eh?" asked Barnes. "How did you do it?"

"A chemically treated cigarette," Grey explained readily. "Great fun at a party. And this is our last party together, isn't it? Here's our snowstorm, fellows. Now, let's go find the Mad Mullah!"

**S**HAKING their heads at the incomprehensible quirk in the brain of Barry Grey, the pilots trooped out toward the line of ships where a waiting mechanic stood at each prop. Ten minutes later the eight planes had formed their formation at three thousand feet directly over the section of flat sand that had served as an airdrome for the past month.



For no particular reason other than a sudden desire to let the others, as well as Squadron Leader Barnes, know that he wasn't asking any favors on this, his last flight in the Sudan, Grey had been the last to select the patrol route he would follow. Naturally, it hadn't been his choice as it was the last of the eight routes to be flown. So now he waited for the Very-light signal from Barnes to fly his route, which was the first one on the right and farthest to the north.

Presently the red Very-light arced out from the squadron leader's plane, and, as each pilot waved the usual good luck signal to the others, the patrol got under way.

For half an hour Grey was able to see the first plane on his left, but soon after that their fan-shaped lines of flight widened. And presently he was droning along alone over countless miles of burning white sand. Holding rigidly to his compass course, he continually swept the sands with his eyes for the faintest signs of movement below that could be horse or camel riders crossing the sands. And as he stared downward he commented to himself for the ten-millionth time upon the utter futility, not to say stupidity, of the entire venture.

In the first place, eight squadrons were needed instead of a mere eight planes. In the second place, it was inviting trouble to send each man out on a virtual solo patrol. And in the third place, it was just downright dumbness not to equip the planes with two-way radios so that reports of movements out on the desert could be radioed back instead of wasting time having the spotting pilot fly to the home base.

"And if somebody *did* have to make a forced landing," Grey muttered and blinked his sun-weary eyes, "what a blessing a radio would be to him!"

But no, they didn't do things like that in the British army. And, after all, Squadron 10 was just a squadron

in far-off Egypt. Sure, dear old England would muddle through somehow. She always did, didn't she? Mistakes could eventually be corrected, but of course there had to be the mistakes first.

"Skip it, kid!" Grey interrupted his rambling thoughts. "After tomorrow what do you care? You'll have served your trick, had some fun in the bargain, and—"

The last froze in his throat, and he snapped his mouth shut hard. The power plant in the nose was still howling its song of mighty power, but the danger signal had flashed on the instrument board. It hadn't flashed actually, but the shooting off of a cannon could not have attracted Grey's attention any sooner. In short, the oil pressure needle was making a non-stop flight around toward the zero peg on the dial.

For a fraction of a second Grey hesitated, as countless thoughts whirled through his brain. An oil line had split, or shaken loose somewhere in the engine. The power plant was still turning over, but, with the pressure at zero, the oil left on the bearings and other parts would be soon used up. That would result in terrific heat—and terrific heat in an unlubricated engine meant bearings burning out and pistons seizing to the cylinder walls, and a complete and hopeless wrecking of the engine. So what?

**S**HOULD he turn back and pray that the engine would last him long enough to get over safe ground? Or should he land and take his chances of making the necessary repairs far out on the desert sands? In either case his chances were fifty-fifty. Perhaps they were fifty-one percent in his favor if he landed immediately, because if he turned back and the engine *did* seize up, he would be completely sunk.

"Here goes!" he said hoarsely, and snapped off the ignition.

Despite the burning rays of the sun that made a virtual blast furnace out of his cockpit, cold sweat oozed from every pore in his body, and a tingling, choking sensation gripped him by the throat. He cursed savagely in an effort to shake it off, but the tingling sensation simply spread down over his chest. Hunched forward on the seat, he raced his eyes in all directions over the shimmering sand.

He saw nothing, however, but that did not reduce the gripping fear a bit. He knew from experience that desert riders had only to stand still, and it was a million and one in their favor that no plane pilot would see them in the sand glare unless he practically hit them a blow with his landing gear.

There was that time at the Alexandria drome when a pilot had landed his ship right on top of a white-garbed native riding across the field on a little white mule. He didn't even know what had happened until he crawled out of his crash.

However, Grey strained his eyes at the rolling stretches of sand dunes until he was so low that the impending landing required all of his attention. His breath stuck in his lungs and he breathed a fervent prayer that it was a level stretch ahead of him. Then he gently eased back the stick to get the tail down. A thousand years of hellish torture dragged by. Finally the plane touched and trundled forward to a stop.

Leaping from the pit, Grey absently noted that there were treacherous sand dunes all around him, the nearest being no more than a quarter of a mile away. But they had looked like flat sand from the air. Silently, he thanked Lady Luck for this one little break and went dashing around the wing to the engine.

Working at a feverish pace, he unfastened the inspection section of the engine cowling and began tracing each one of the oil feed lines. It took him

three minutes to find the one that had caused the trouble, and when he spotted the cause, a great wave of heart-throbbing relief surged through him. It wasn't a broken line that might take hours to fix, if not longer. No, vibration had caused the locking nut of an elbow joint in the line to unscrew itself and slide down the pipe away from the joint. Naturally, the cup-shaped end of the pipe had slipped off the nipple of the joint and prevented free passage of the precious oil.

Tearing back to the cockpit, Grey fumbled wildly in the cockpit box for a small wrench. He found one and dashed back around the wing to the engine. His hands trembling in excitement, he forced himself to take it easy and screw the locking nut back into place without stripping the threads.

When all was finally set, he fastened the cowling section back into place and furiously piled sand in front of the wheels to serve as chocks. Then he raced back to the cockpit and lashed the stick back with his safety belt. Opening the throttle, he returned to the prop and swung it around several times until it was on compression.

"Please God!" he breathed, and went to the cockpit once more to snap on the ignition switch. "Please God, make her catch!"

His hands on the prop blade, he paused for the fraction of a second. It was almost as though he were afraid to swing the prop and find out that the engine wouldn't catch because too much oil had been drained out of the broken line. If that were true—

"Blast it, swing!" he shouted hoarsely, and pulled down with all his might and jumped back.

**T**HE power plant coughed, and before Grey's agonized eyes the prop seemed to come to a dead stop in its arc of travel. But not quite.

It virtually quivered, and then another spark jumped a spark plug gap, and, in a burst of sound that went roaring across the white, burning sand, the engine caught and kept on going. With a wild yell, Grey spun on one heel and started tearing around the wing. He had taken but three short steps when the shrill screaming of Hell's demons crashed against his ears, and a swarm of blood-curdling hellions of the desert came thundering in on him from all sides.

His heart like ice in his chest and his eyes wild with alarm, Grey tried to swerve around the wingtip and make a desperate leap for the cockpit. But he cut the wingtip too close. It gouged deep into his side. He bounced away to fall sprawling on his face in the sand. And before he could scramble up and reach for his holstered automatic and his vial of poison, strong hands gripped him and held him powerless!

There were at least eighteen of the white-garbed, cork-burnt-faced bandits. Two held him in an iron grip, the others remaining astride their beautiful racing camels. Each camel was loaded with a conglomeration of articles besides its rider. As Grey swept his eyes over them his heart dissolved in his chest. He saw a machine-gun on one camel, boxes of ammo on another. On a third was a rolled-up bunch of what at first glance looked like rags. But a second glance showed they were British uniforms—torn and blood-soaked British uniforms bearing the insignia of the Armored Car Units!

A screaming torrent of words cut short Grey's thoughts. He did not understand them because they were spoken too fast, but when he turned his head and looked at the speaker his head began to throb and his throat went bone-dry. The speaker was mounted on a pure-white camel, and the harness trappings were like those from out of a story book. They were studded with hammered gold and

wound in places with gay-colored cords. The saddle blanket looked more like a beautiful Persian rug, and the saddle itself glittered in the sun like an ever-changing rainbow.

But Grey took all that in, in a sweeping glance. Then he raised his aching and sand-filled eyes to the rider. And when he did, he instinctively sucked in air in a rasping gasp. Completely clothed in flowing white, with no single spot of color save a red-and-gold head cord, was a small man with a gnarled, wrinkled cork-burnt face absolutely repulsive to look at.

Only his eyes looked human, but when Grey stared into their glittering depths he saw the smoldering flames of a desert wolf gone stark mad. And he knew that he was looking into the glittering, fiendish eyes of the Mad Mullah! To prove it he had only to remember the pictures of the Mad Mullah he had seen at Middle East Headquarters.

The man screamed words again, and before Grey could take a second breath his gun was stripped from him and he was sent stumbling forward to the side of the pure-white camel. The Mad Mullah leered down at him, showed scragged teeth in a twisted smile. Then he spoke slowly.

"You speak our tongue?" the man asked in Arabic.

"I speak thy tongue, Oh, Mighty One," Grey replied, putting emphasis on the last three words. "But I speak it only as a growing child who has not yet learned all there is to learn."

"Be it so by the Beard of the Prophet!" the bandit king murmured. "Tell this to me, then. What has the son of dogs to offer for his life?"

**G**REY'S heart leaped with faint hope, but confusion ran wild in his brain. Why was the Mad Mullah asking questions instead of strapping him across a camel's back to be taken to the tribe women? He stared for a moment at the thin, curved knife

the Mad Mullah held loosely in his hand. One swift, sweeping lunge with that knife and Grey's head and shoulders would part company. He swallowed fearfully at the thought, and then looked up into those glittering eyes.

"What can one offer for his life?" he asked slowly.

"Gold and jewels," the Mad Mullah said, and then laughed harshly. "But dogs do not possess gold or jewels. Not even though they come from far-off lands. There are things more valuable than either. There are things that one can speak with the tongue."

Grey breathed easier, though his heart continued to hammer madly against his ribs. The Mad Mullah was sparing his life for the moment because he was after something. And that something was information.

"And what could one speak with the tongue?"

The desert bandit held up one hand.

"For as many nights as one can count on this hand," he said, "there has been a caravan that makes loud noises travelling across the sands. There are dogs of your blood in that caravan. You will speak and say where they shall be, when they come to the end of their journey."

Grey suddenly realized what the Mad Mullah was talking about. Cold sweat drenched him anew. A little less than a week ago four Armored Car Units had left El Obeid to meet a huge commercial caravan at Dibella and act as an escort east to Khar-toum. The Mad Mullah had naturally guessed that the cars were to meet some rich caravan. Or else, it was some kind of a trap being set to catch him. That was the information the desert killer desired.

His brow furrowed as though he was giving deep thought to the Mad Mullah's words, Grey let his eyes stray over the pure-white camel. Strapped fast in back of the Mad Mullah's saddle was some of the loot

from the stalled armored car wiped out at the Fada Oasis. And in true bandit style it contained even the most worthless of articles. Three five-gallon tins of spare gasoline were tied to the pack. Their caps were missing, showing that they had been emptied probably before the attack. But the Mad Mullah had taken them just the same. They hung like pendants from the pack and clanked together every time the camel moved.

**T**HEN suddenly, Grey's heart gave a leap and it was all he could do to lean forward for a closer inspection. One of the cans must have had a little gasoline left in it, and the continually banging together had caused the can next to it to split its seam at the bottom and thus permit the raw gas to leak out.

For as Grey stared hard, he saw that the lower half of the pack of loot and a considerable portion of the saddle rug was soaked in gas. In fact, the hem of the Mad Mullah's flowing white robe showed gas-stained rings. Then the Mad Mullah's harsh voice cut his thoughts like a knife.

"Speak, dog of dogs! There are words you can tell me for your life in exchange."

Grey hesitated and stared earnestly up at the man. He gestured grave concern with his hands and then hooked his fingers in his tunic pockets.

"There are words I can speak, Oh, Prince of the Desert," he said fluently. "But I speak as a learning child and must think for the words. It has been so spoken that you have only death for dogs. What if I speak the true words? Will it be death just the same, or will thou swear on a hair from the beard of the Prophet? If thou cannot so swear, is not death the same as my tongue to be cut from my mouth this moment?"

Pulling his hands from his pocket, Barry Grey raised them in a pleading inquisitive gesture. Then he held

them out to the side in an attitude of respectful waiting. The Mad Mullah glared down at him for several moments, and in that short space of time Grey knew for sure what he had already guessed. Whether he spoke the truth or lied his head off, the Mad Mullah's reward would be nothing but a horrible, torturing death. Sweat rolled off Grey's face and his arms held out from his sides ached. But he steeled himself and kept his eyes riveted on the Mad Mullah's face. He knew that every one of the bandit's followers was watching their leader and waiting for him to speak.

Then slowly, the Mad Mullah's lips slid back over his scraggly teeth in a crafty smile.

"What I swear shall depend on the words I hear spoken," he said, slyly. "Dogs that eat their young can speak words that are not true. Speak you, then, and I will judge if I am to swear my oath."

Grey wanted to scream, to yell at the top of his lungs and leap up at the ugly-faced desert killer. His life hung in the balance of split-seconds, and if one of these bandits should shift his eyes from his leader's face, or if the Mad Mullah himself should look out at Grey's hands. . . .

And then it happened!

The pure-white camel let out a piercing scream and vaulted high into the air, almost unseating its rider. And a split-second later, flames blazed up the camel's rump and oily black smoke swirled about. The half-crazed camel spun on its forefeet and lunged widely into the camel next to it. The flames blazed up even more, and in the flash of an instant desert bandits and camels were in a screaming, whirling turmoil.

But Grey didn't wait to watch. The instant the flames sprang up and the pure-white camel vaulted into the air he swung his right clenched fist at the nearest of his guards and sent him sprawling on the sand. And in a continuation of the movement he leaped

back, spun around and raced madly the dozen steps or more to his idling plane. In a single leap he piled into the cockpit, and even as he hit the seat he whipped the safety belt off the stick, grabbed the throttle and pushed it forward.

The idling engine roared into full-throated sound, but for one hellish long second the propeller was unable to drag the wheels through the sand piled high in front of them. Actually, the plane tilted precariously by the nose. Then the sand gave way against the pressure, and the plane virtually leaped forward.

Shots and screams rang in Grey's ears. A white-hot spear of flame nicked his right shoulder and then he let out a bellow of wild alarm and jammed on left rudder hard. A crazy runaway camel was charging straight toward his right wing. If it crashed into the wing the plane would be wrecked and he would be a dead man before he could even crawl out of the debris.

**F**ROZEN to the seat, unable to move, Grey stared glassy-eyed at that charging camel, and then gulped out a sob of joy as the right upper wing grazed its extended head and swept on by. In the next few seconds Grey pulled the ship clear and went zooming heavenward, as a hail of bullets from the guns of the raging, flame-engulfed bandits streaked up after him. Sawing rudder to throw off their aim, Grey waited until the ship was near the peak of its wild zoom, and then threw it over on wing and let it drop.

"Sez you, you bloodthirsty demons!" he roared, and went plummeting down at the bandits as they started to scatter in all directions and go streaking out across the sands.

His thumbs firmly on the trigger trips of the six-hundred-round-a-minute guns, Grey tapped rudder slightly until a thing of smoke and fire tearing across the sand was in his



sights. Then he jabbed both trigger trips forward. The twin guns mounted forward yammered and snarled their death song, and a hissing load of death piled straight down into the Mad Mullah and his fleeing camels.

Both beast and rider went flat as though they had charged into an invisible stone wall, and lay still. Cutting his fire, Grey nosed up slightly and wheeled on wingtip. Then down he slanted again, guns blazing. One, two, three camels and their riders died in full flight and spilled flat on the hot desert. A bandit mounted on a camel fully loaded was next. Grey shot him clear out of the saddle, but permitted the beast to keep on running toward freedom.

Then another bandit joined his blood-letting brothers. And still another. And before five minutes had ticked past, eighteen dead men and twelve dead camels dotted the sands

within a mile-square area. And from at least half a dozen of the still forms tiny wisps of smoke drifted up toward the relentlessly blazing sun.

Pulling up for altitude, Barry Grey leveled off and for a moment or so debated the idea of cutting due south in the hope of contacting the plane flying the route next to his. But he decided against it. He decided, also, against continuing his patrol and meeting the others as arranged. Instead, he wheeled around to a compass course slightly south of east and gave the ship its head.

"We'll tell them later, and they can check for themselves," he shouted aloud and punched the throttle. "We're going home, baby, and do I mean home!"

With a nod for emphasis he pulled the magnifying glass from his pocket and kissed it in deep appreciation for the life it had saved.

LOOK FORWARD TO—

# EXILED WINGS

NEXT ISSUE'S FEATURED COMPLETE BOOK-LENGTH NOVEL

**ZING!**

**RING!**

**CLING!**

**Whisk Off Tough Beard Easily With Smooth-Shaving PROBAK Jr. Blades...**

**Twenty For A Quarter!**

RECEPTACLE FOR USED BLADES INSIDE!

PROBAK JR. BLADES

20 PROBAK JR. BLADES THE SON OF PROBAK

20 FOR 25¢

4 FOR 10¢

# THE STORY OF THE COVER

By LIEUT. JAY D. BLAUFOX

**T**HERE was talk in the R.A.F. officer's quarters of the new arrival of a secret American fighter plane as part of the Lend-Lease Aid to Britain from the United States.

There was great speculation as to its performance; some said that it was overrated; some said it would have to be revamped for British use.

Some still insisted that it would have as little chance against the Messerschmitts as an ancient Canuck Jennie would have against the Spitfires; but they were speaking of the Airacobra. The ship which spat shells through its spinner nostrils; one of the first of the American planes to include a cannon in its armament.

They argued back and forth until they were called to Operation's Office for instructions. Over the huge map that covered a table almost the size of the entire room, the pilot-officers were told they would escort a squadron of Lockheed Hudsons to Dortmund. As soon as the Hudsons had laid their eggs on their target, the Airacobras were to be pushed down and the target strafed with cannon and machine-gun fire until there wasn't a stick left standing in the place.

## *Seals With Wings*

Like seals with wings, twelve Airacobras rode off the tarmac with some very dubious pilots at the controls. At the rendezvous of twenty thousand feet they met the Squadron of Hudsons headed out over the English Channel and rising five thousand more above them spread out in a huge Vee and followed on.

The day was clear. The run to the Ruhr was uninterrupted. It seemed that Joe Stalin was giving the Gerry worms a tough assignment on the Eastern Front. The Luftwaffe just waffled around.

Dortmund lay still and it looked frightened even from twenty thousand feet. Tall spire-like smoke stacks rose invitingly up at the Hudson Bombers and the Airacobras just begging to be knocked down.

Then hell broke loose over Dortmund. Cigar-shaped ring-tailed bombs dropped through open bomb compartments and went screaming for the stacks below.

One by one they thundered their detonating explosions that forced the bombers and interceptor fighters up with the pressure even at their great height.

The steel casing of the bombs—500 pounds—shattered like egg shells as they blasted the oil tanks and cast the burning oil splattering black with smoke into factories and munitions works. Bombs laid



low the armament works as the proud smoke stacks fell across lumbering freight trains and wrecked them. Oil for the engines of Germany; oil for the hot bellies of Hitler's steel satellites went spilling and flowing, smoking and burning and sinking into the soft dirt about the factories.

## *Burning Tankers*

But the bombers had left too much standing and the signal was given for the Airacobras to break formation. Down they roared with their full-throated 1090 horsepower Allison wide open.

Pilots screamed inside their cubicles in an attempt to compensate for the sudden changing air pressure. Down, down they dived and with their Airacobra noses running death and devastation in a streaming flame, they attacked the rolling oil-tankers and one by one set them to burning, not for Hitler but for Churchill.

Messerschmitts foolishly attempted to intercept the Airacobras. Cannon fodder! Burning, blasting cannon minced-meat that even their own designers could not have recognized if they had wanted to; that was their end. Great burning gaping holes replaced the stiff German smoke stacks that had lined the factory roofs.

Oil tanks which still held oil were pits of spuming, fiery geysers. Oil tankers lay on their sides now by the side of the ripped-up railroad tracks. And the men who rode out with cynicism in their brains, and ridicule in their hearts for the Airacobras rode back patting them proudly on their metal humps.

Ambrose and Muley Outdo Themselves Getting Each Other Out on a Limb—but it's the Germans Who Get Sawed Off as Usual!

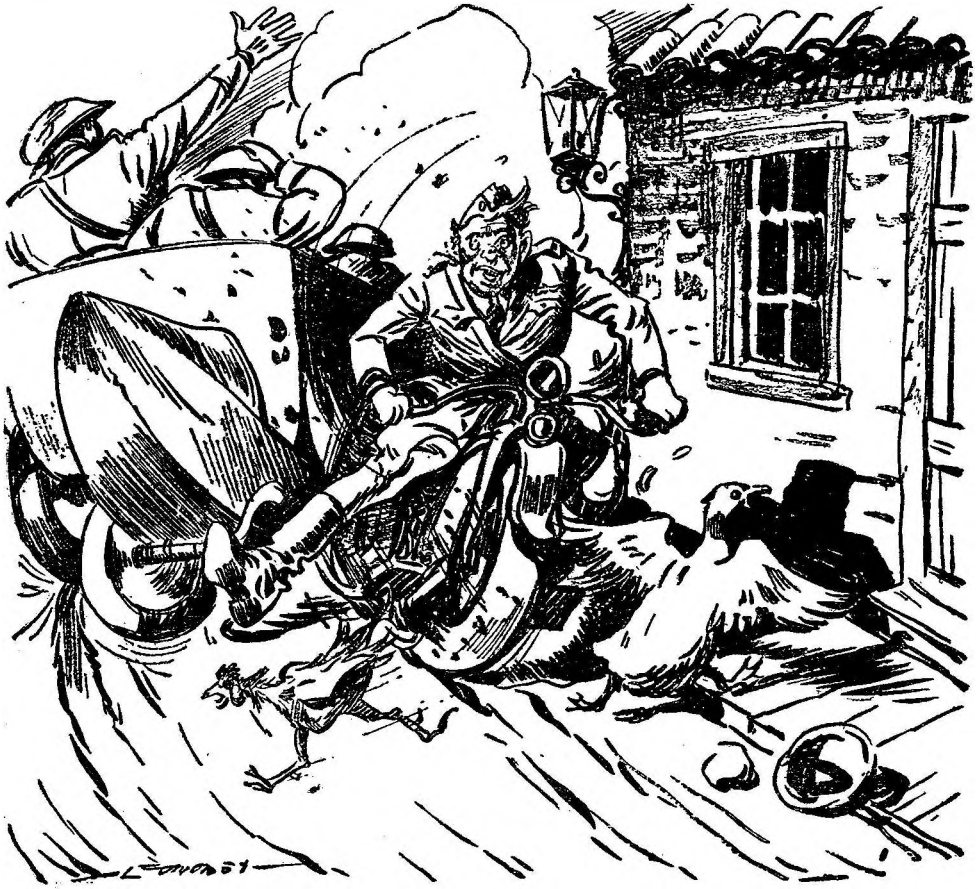

I rounded a bend in the road and put on my brakes fast

# BIRD FEUD!

An Ambrose Hooley Howler

By JOE ARCHIBALD

*Author of "Blunder Buses," "Spandau Re Mi," etc.*

**S**OMEDAY somebody will ask me, Muley Spink, what caused the Allies the worst trouble during the World Guerre Number One, minniewerfers, poison gas, liquid fire or Jack Johnsons. I will tell them

none of them as dames was worse than anything. If they won't believe me I will send them to Ambrose Hooley.

Me and Ambrose keep house together in a Nisson on the drome of Major Bertram Bagby's Ninety-third

Squadron near Commercy and also help to fight the Heinie circuses between meals. Ambrose Hooley is a grotesque-looking tomato who is liable to take a poke at a citizen at any time and for no other reason than to make sure his timing is right.

Ambrose comes into the hut one afternoon and he has a pan as long as a squaw's that has lost a papoose out of her rumble seat. Ambrose has not been himself for three days, thank heavens! His appetite, usually as potent as that of a team of hard-working brewery horses, has fallen off and for two nights he has had no more shut-eye than a citizen needled by two ulcerated wisdom teeth.

"What is eating you, Ambrose?" I ask. "It couldn't be anything less than your finding out you have caught leprosy some place."

"It is Euphemia, Muley."

"Oh, is that a bad disease?" I ask, very concerned.

"Don't try and be funny," Ambrose barks. "You know very well it is that dark-eyed nurse at Lerouville. I was over to see her last night, and she treated me like an installment collector who come for a pianer. She says all her time was took up by a poor wounded Frog looey who was gettin' over bein' nudged by a shell. You can't trust dames, Ambrose. Three times now she has give me the air."

One of the blunders of the Allied command in the *guerre* was to put hospitals too near airdromes and also to put good-looking Florence Nightingales in them. Nobody bothered with the dolls at the repair shop until Euphemia and a pal of hers, Chloe, happened to get assigned to it. Then the Ninety-third squadron started to think of full moons and birds and bees.

"You do not understand women," I says. "They are a science, Ambrose, and as you never went to school, you wouldn't know about that. They have maternal instinct and like to dish out sympathy. Who do they run to every

time a fight is over even though, in the fight, their steady wins? They go to the guy who is pancaked, with his prop boss bashed in and both of his eyes closed up like saloons on Sunday in a blue law town. Healthy fellers don't interest them."

"You are nutty," Ambrose says.

"Now if you should crack up an' get all covered with blood and land where the dame could reach you, she would run to your side and make a fuss over you, Ambrose.

"The looey would be as popular as a worm in an apple. Of course, I hope a Von does not beat you to the punch tomorrer as we are pals."

"I will take your advice, Muley," Ambrose says nasty like. "I will sit down and write a note to drop over by von Giblitz's drome and says I am Lieutenant Hooley who wishes to git wounded, but to be sure it is only a nick as I wish to make an imprint on a swell nurse. You would cure a guy of hives by skinning him, wouldn't you, Muley? Just leave me be and I will work it out by myself. Love is awful."

**I** LEAD Ambrose over to the mess. Major Bagby is there, straddling a chair and resting his arms over the back of it, and he insults us while we eat.

"The way we're goin' lately," the C. O. says. "The brass hats have cooked up an idea. They want to know why it wouldn't be a good idea to swap dromes with the Krauts as they are over here more than we are. They also said if we come to France to look at the scenery, we should have gone to the Pyrenees."

"Oh, yeah?" Ambrose says. "The only time they get near the *gare* is when they want their mail. That reminds me, Muley. Was there any from Uncle Willie today?"

"There was not. As long as he does not write, we keep out of Blois," I says. "Why don't these Heinie circuses like von Giblitz's make one-

night stands, huh? We will find out how good they are tomorrow, won't we, Ambrose?"

"Yeah. Maybe I will git smacked by a Jerry, Muley. I have an idea I—"

"Don't tell me. Every time you have got one in this *guerre*, it was poison to me." I wish I had kept my mouth shut about the dame, but nobody ever picked up a pail of milk after they had dumped it down the sink.

"I do not feel hungry," Ambrose says. "I think I will go out and ask the mess attendant for somethin' very light like crackers an' buttermilk. I will see you later, Muley."

"I'm afraid so."

Ambrose is sitting in the hut and scratching his roof when I finish the mess. I tell him tincture of larkspur is good for things that jump, but he lets it go over his head. He shows me a letter. It has already been opened, but Ambrose says he did not do it.

"It is addressed to Bagby and is in a doll's handwriting, Muley," the little crackpot says. "It still has a smell to it. The postmark is Paree."

"You take that right back to him," I says. "I bet you would open it."

"I am an officer and a gentleman," Ambrose says. "Here, you give it to him. He will not believe either of us if we say we didn't read it. You know that."

"It is just as bad gettin' shot for an oriole as it is for bein' an eagle, isn't it?" I says. "Read it, Ambrose."

It went like this:

Dear Bumpikins:

This is to let you know I will be in Bar-Le-Duc on the twelfth of August, and you just must get to see me. Remember the times we had in Oshkosh? I am singing with a troupe and will not be in Bar-Le-Duc over an hour. The boys in the trenches have to be cheered up, don't they? The doughboys near the Argonne said I was better than Elsie Janis. I will run off and marry a French Colonel with whiskers if you don't come and see me. Your same old  
Gladys.

"Bumpikins!" I says. "Cripes! You

would not think Bagby would git called that. I will not be surprised to meet a gorilla named Cyril now. This is the tenth, isn't it, Ambrose?"

"Yeah. Take the letter and drop it in through the window of the Operations shack, Muley," Ambrose says.

**T**HE next day we start out in the Spads with Bugeye Boomer, the flight leader, showing the way to von Gublitz's circus. It is not long before we bump into the Heinies over Thiaucourt and before you know it four Halbs have got Ambrose backed close to a corner pocket and are using him for an eight ball.

The Vons must have missed up on their cues, as the little tomato fights his way out and I see one Halb back up quick like a pooch that has stuck its prop boss into a hot plate and then it does a back flip and starts for the dump.

It is not human, the way Ambrose can fight, upstairs or down. Another Halb does a low bow and can't straighten up and it keeps on bowing until it gets to the carpet. The Boche pilot does not do an encore.

Bullets spatter me, and the Spad under me shakes so it would have soured a jar of cream if I'd had same in the pit. I duck another burst and climb and then I see it is von Gublitz himself who is after me.

Bugeye and Ambrose come in at him from two sides and the Kraut just misses the jaws of the trap but leaves a piece of his empennage behind him. I wipe the jitter juice from my pan as for a minute there I was sittin' pretty like I was standing by a volcano crater and gasoline started to rain down.

The Halbs see some other Allied crates coming in, and they give their power plants the goose and fade out. I climb up a little and inch in close to Ambrose's Spad, and the crate looks quite frazzled. The little lug, however, could land anything from any height as long as there was a seat



under him so I do not worry about him.

But he does not make the drome. Close to the hospital at Lerouville he starts doing tricks with the Spad and he knocks off a pole bearing a Red Cross flag that is glued to the hospital and then turns turtle. The Spad, not Ambrose, as his shell is thick enough already. It happens that Major Bagby is driving along the road from Lerouville to Commercy, and his flunky stops the boiler not fifty feet from where Ambrose smacks the real estate.

**A**N AMBULANCE comes down the hill from the healing hostelry and backs it up close to the wreck of the Spad. Two big citizens alight and take a stretcher to Ambrose who crawls out in the clear. He passes out or seems to, and when he feels a hand on his dome, he sighs.

"Is it you, Euphemia?" he asks.

"Naw, an' it ain't Alice," a big medical corps non-com says. "If you wasn't already bleeding, I would make you. Them two dames was tranferred again."

"I been doublecrossed. You let me up," the little tomato says. "You would make who bleed?" And Ambrose boffs the medical husky right in the chops. It is right then and there that Major Bagby comes up, and he kicks a bottle that is on the ground with his toe. He picks it up and finds it is catsup and the brand we use on the Ninety-third.

"You fakir!" the C. O. says. "It is good I came along. So you cracked up to have a dame cuddle you, hah? Catsup! Oh, you cluck. This'll bust you all the way to—"

"I did not," Ambrose says. "I always carry catsup with me when I fly as it is so good for a thirst. It tumbled out when I hit. You try and prove different to any U. S. prosecutin' attorney. Oh, wait'll I see Muley Spink."

I was told all about this later.

The dough that Ambrose hits climbs back into the ambulance and drives off, but he is still gaga and tries to drive between two trees that is really only one tree, and then another ambulance has to come down from the hospital to pick up the crew of the first one. Everything is blamed onto Ambrose Hooley, which served him right for cracking up a Spad on purpose, being responsible for the wreck of an ambulance and all. The C. O. says he is under arrest and is on his honor not to try anything. Just as if the little halfwit had any honor.

Ambrose finally arrives at the hut and says he is through with me.

"You did it on purpose, Muley Spink," he says. "You knew Euphemia was not there anymore, but put me up to it anyways. You knew I'd try what you told me to. Oh, you snake in the grass."

"Wha-a-a-a?" I gulp out. "If I told you to put a leg into a shark's mouth, would you? Look here, Ambrose. It is your own fault and what you will get from a court-martial won't be enough to suit me. I—"

Ambrose smacks me, and I see big dippers, a milky way and the ring around Saturn. When I am able to talk, I speak up.

"That settles it. Don't you dare speak to me ag'in, Ambrose Hooley. Look, I am drawing a chalk-line between my side of the Nisson an' yours. You dast cross it and I will hit you with the first thing I pick up, which I hope is an anvil!"

"That suits me," Ambrose says. "I never saw you before in my life and you act like I hadn't or I will wade into you, Spink. A fi-i-i-ne pal. I will have no more truck with you."

"I was never so happy," I conclude.

Ambrose stands by and watches us take off for another patrol at mid-day.

When I get back fifteen minutes later with the crate that looks like a soup strainer, he has a disappointed look on his face. I hear

him speak to a pilot as I trudge to the Operations shack.

"There's always a next time, and maybe von Gublitz will aim better."

I give the cold-blooded crackpot a disdainful look, but nothing could wilt him, even three direct hits from a flame thrower. I go out with Bug-eye two more times before curfew rings. When I climb out of the Spad with the sun going down, there is three brass hats making a tour of the drome with Bagby, and they stop and look at the crates that had just landed.

"Don't they ever win?" a colonel says. "This outfit is mill-dewed, Major. Sloppy looking field, sloppy looking pilots, sloppy everything. If things don't perk up around this outfit, there'll be a shake-up. Look at that pilot over there. How did he get into an air force?"

Ambrose hears the brass hat, and he comes over and says he is going to bust himself a brass hat before they ship him to Blois. Bagby says for me to grab hold of Ambrose and reason with him, but I make out I am numbed by a Spandau slug and go on past. I hear a sound like a flat side of a broadax smacking against a bag of oats, and I look back and see a colonel very limp in the C. O.'s arms.

"And no discipline either," a brigadier says. "You put that flyer under arrest, Major."

"Where do you think I've been?" Ambrose yelps. "Playin' cribbage with Pershin' an' Foch? Hah! You are askin' the Old Man to lock up the horse after they have stole the stable. I'll see you in court."

**A**MBROSE won't come to the mess. We are eating it when we hear a terrible commotion outside, and we all run out. Ground men are running and waving their flippers, those who are not spread out on the real estate. A Spad is taking off, and a grease-monkey is flying from a strut like he is a dame's good luck stocking.

"Fire at him," Bagby howls.

"He has my crate!" Bugeye trumpets. "Somebody stop him."

"Yeah," I says. "After you do, try and scoop Niagara Falls back with a teaspoon. Ambrose does not want to die in disgrace in a U. S. hoosegow."

Major Bagby finally grabs a flight sergeant and asks him why he did not stop Ambrose, and the non-com says he did not have an ax or a shotgun. There are two other groundmen just sitting up, and one has lost two teeth and the other says he wants a piece of wire to get his jawbone straightened out.

"This cooks us," Bagby says. "We are in the doghouse at Wing now. A deserter! We will never live it down."

We do not hear anything from Ambrose that night, and there is no sign of or news from the halfwit most of the next day. But at noon mess, the word comes in. A crazy man is flyin' all over the sector and has shot down a Rumpier, two Fokkers, three balloons and one Halberstadt. A Spad outfit near Luneville called up the C. O. and says there was three brass hats with sore feet in his Operations room there.

"They claim an aviator held them up on the road and took all their gasoline," the squadron commander told Bagby. "Had a gun and a rubber hose and made them siphon all the fuel out of the boiler. They think he is a Heinie in an Allied uniform, as no Yank ever looked so desperate."

"He better not come back," Bagby says. "He'd better git shot down. This outfit will give way to a Salvation Army doughnut outpost." The C. O. stamps around the mess shack and stops every once in a while to bang his noggin against the wall. The phone rings in his office again. He goes in and answers it and then he comes out looking like he has just had Joan of Arc as a visitor.

"An outfit near Vaubecourt called. A Kraut just walked in and give him-

self up there. It is von Gibriltz," Bagby gulps.

"Just let Ambrose be," I says. "He will have the *guerre* over by Saturday night. He must be in an awful temper. I bet he was the guy who shot the Duke at Sarajevo anyway and started it all."

I take a long drink of cognac and chase it with a longer one. No more news comes from Lieutenant Hooley, and, close to dusk, I says Ambrose is now out over the North Sea and lookin' for subs.

"Well," Bagby says. "I have to go over to Barley Duck tonight. I better get spruced up. Tooth has been bothering me, ha ha. Can't sleep with it." He tells an orderly to hop out to the E. O. and tell the guy to gas up a motorcycle with side-car.

"Dames again," I says. "Bumpikins. What an army!"

A little groundhog enters and hands Major Bagby a letter just as the C. O. is about to go up to his quarters.

"Lootenant Hooley left it with me, sir. I forgot about it until now as the wallop the Lootenant handed me put my dome a little off up. He stuck it in my pocket while I was kayoed, I giss."

"You read it, Spink," Bagby says. "I ain't got time now."

**I** DO. I says to myself it is almost Ambrose's last will and testament and maybe he wants to say he is sorry we had to be mad at each other. I should have known better.

Dear Bagby and Spink:

You both drove me to this and I won't never forget and will haunt you if I go West. Muley Spink and his ideas! An' you arrestin' me, you half-baked squadron commander! Nothin' has no fury like a Hooley scorned, and I will have a eye for a eye and a tooth for a tooth. Even if I have to come back from the grave. Mud in your eyes.

Ambrose.

"That is childish, huh?" I says to the C. O. when I show it to him later.

"He has the brain of a kindergarten," Bagby says just as the phone rings. When Bagby gets through yessing, he bangs up the phone and acts more childish than Ambrose Hooley. He bites his nails and kicks his chair over.

"Those cussed brass hats!" he yowls. "Of all the nights they have to come over here. Ten o'clock they say, Spink. Have work cut out for this outfit. On the result depends the status of the Ninety-third, they says. Our one last chance. How can I get to Barley Duck and back and have time to see a dentist?" He sits down and looks at me.

"You will drive the motorcycle," he says. "I never saw nobody make one go so fast as you and over pastures and meadows at that. Hurry up and get ready, Spink. The brass hats are not going to stop me from going to see about a tooth."

"No," I says. "I will get you there and back before ten or my name is mud."

We have trouble on the way to Bar-Le-Duc. A tire goes *ph-t-t-t*, and it takes me a half hour to fix it. Bagby gets insulting, and I forget myself and tell him that dames will ruin everything yet. Look what one did to Ambrose. Now this Gladys—

"So you read my mail, Spink," Bagby yells. "Wait until I get out of this bathtub."

"Oh, don't waste no more time," I toss at him. "I can keep my mouth shut."

"Yeah. Maybe. Well, get goin', Spink!"

When we arrive in the Frog town, we go our separate ways. I happen into an *estaminet* called *Le Cafe de Le Chat Noir* which means saloon of the black cat in English. It is bad luck in any language, as I was soon to discover.

I sit and go quite deep in my cups, as I think maybe Ambrose is no more at the present moment. Being in a *guerre* without Ambrose is like ba-

ing a piece of toast without a poached egg.

Do not miss anything that follows as it goes to show you how much trouble Ambrose can make without being helped by his Uncle Willie.

Into the oasis prances a Frog looey and two R.A.F. pilots, and they each have a femme with them, and I can see it must be about the tenth grog shop they have visited. They come over to my table, which is the only one left that has room at it, and a Limey looks at me nasty and says I have no right to hog a whole table.

"Go away," I says. "I am in no mood to argue. "I cannot afford to get into no fight, but I have got myself many things I could not afford at times. If you get too fresh—!"

"Peeg!" says the Frog. "You would let ze *mam'selles* stand on zere feets?"

"*Oui M'sewer*. "If they are able."

"Now look, old chap. We're arskin' you in a nice manner," a Limey says. "If we cawn't reason with you—"

"Go away," I says and push the Limey. The femme with him says for him to hit me which he does, and then I smack the Limey and the other pilots poff me, and an awful fight is on, just when I am there mindin' my own business.

**B**EING in a fight without Ambrose is like flying a Spad without a joystick.

Everybody in the oasis sides against me, and gendarmes enter. M.P. whistles start blasting from there to the channel, and I get to a window and dive out of it. It is an awful eye I have got and can only see out of one.

The mechanical bug is where I left it, and I get it going just as three tough A.E.F. cops reach for me.

I sideswipe a boiler loaded with brass hats and lose the side car and most of the front wheel. I slide down a long hill, and I must have been half kayoed by punches as I think I see

Ambrose Hooley standing on a side walk watching me go by.

There is another officer with him, but his back is turned. It is hallucinations I am getting, I says—my past flying past me before I get fatally wounded. I end up in a Frog cellar and think of Bagby for a second.

"He is on his own now," I gulp and hurry upstairs, and then a blood-curdling yell lifts me off my feet and out of my good eye, I see an old Frog and wife sitting up in bed with their hands up. I go out another window. I land in an alley and am running as I hit, and if anybody could have clocked me, they would have seen that Muley Spink ran a two-minutes mile from that point.

I hide in a ditch for a half hour and then go on again. I round a bend in the road and put on the brakes fast and blink my one peeper. A Spad is sitting on its haunches not twenty feet away, and leaning against it is Ambrose Hooley.

"Oh," I says, putting on speed again. "It is me, Muley, Ambrose. You can see I am hard-pressed and you can hear the whistles blowing. Let me have the crate, huh? Let's bury the hatchet."

The little tomato looks at me sour. Then he narrows his eyes and goes to the nose of the ship and grabs hold of the prop. I get into the pit and switch on and Ambrose still won't speak to me. He buried the hatchet all right, I found out later—right up to the handle in my noggin.

The Hisso starts perking, and I hop off and leave Ambrose standing back in the field with his arms folded, and his ugly pan turned away from me. He sure can hold a grudge. I climb up high and then tumble to the fact that there are no more instruments on the dash than there is feathers on a seal. Spandau lead has washed them up. I have to fly for Switzerland by memory. There is wires loose on the crate, also a strut doing a shimmy.

"Well," I says. "I couldn't expect

the bum to have had time to take it to a repair shop. Somethin' is screwy here. What was Ambrose doin' out by that Spad?"

I keep asking myself questions. Did I see Ambrose in Bar-Le-Duc, really? What was he waiting for outside of that town. Just as if he had been in good standing on the Ninety-third as a Rhodes scholar. All he could have been waiting for, I tell myself, is a court-martial for wrecking government property, assault on superior officers, desertion and highway robbery at the point of a gun.

"He let me have that Spad too quick, that crackpot!" It is getting foggy upstairs, which is healthy like walking through a forest fire balancing two kegs of black powder in each hand. I wonder if the soup has any ceiling and go up higher.

"Oh, you are dumb, Muley!" I tell myself. "You have left the C. O. back there, and he will stay until the last minute and then he will find he has no way to get back. The Ninety-third is washed up as it can stand no more demerits. Two deserters already, and Bagby not showing up to get the final exam papers for the outfit. Well, when you hear a St. Bernard dog bark, go down and get interned."

I do not hear a pooch bark. Instead there is a sound nearby that is like a lot of mill machinery working even though it has had monkey wrenches thrown into it. I look up and get scared as bad as a colored gamin who passes a boneyard at midnight and sees an angel on a gravestone fly away. It is the big snout of a Heinie corona pushing its nose through a big gob of mist—a Zep, no else.

"Surprise!" I yelp and take a crack at the big gas bag that must have been chased away from the channel with a lot of Vickers lead in it. Anyway, it is up there with Muley Spink, and I try my best to light the stogie.

Krauts take a poke at me and do not miss by much, and I reach for more altitude and then nose the crate

down and give the Zep all that is left in the Vickers which is not muth, but the tracers sizzle the wrapper of the Potsdam panatela and then there is an awful blast when the filler ignites, and it drives me upstairs and as close to the moon as I want to get.

**I** THINK I make out the outlines of a ball park there before the Spad starts settling again. A strut wiggles close, and the Hissso starts coughing like it had caught a bad cold at such a high altitude. I am only ten thousand feet up and that is a h— of a place to get out of gas.

I start downstairs, and there is a big bonfire lighting up the sky chute for me, and it is the Heinie cigar. I know that when it hits, it will be quite a butt to be sniped. There is a big shower of sparks when it hits, and then comes a lot more loud banging sounds which are very puzzling.

Getting down is no lark. Even Ambrose Hooley would have had the jeepers if he had been in my place. I go down in long sweeps, and sometimes I am upright and sometimes vica versa, and it is lucky I am vica versa when I make contact with the linoleum. I wondered what it was hit me on the noggin just as the Zep blew up from my Vickers burst. It rolled into my lap and thence into the pit, and I was thinking about it just as somebody blew out the lights.

When I open my one good eye, I see I am in a big box.

"They gimmie a coffin big enough," I says. "But they buried me with some other guys as I can hear them talkin'. Hey, what is your names? How was you killed at the same time as me? And where?"

"Oh, you alive?" a dough says who is driving the truck. I can see it is one now. They tell me I almost used it for a hangar.

"You ain't human, Lieutenant," one says. "I don't see how a feather could have come down in that crate without gettin' broke in three pieces. Drive



to the first aid station near Dommartin, Hank. It is no use goin' to a cemetery now."

"Has any of you some bicycle tape?" I ask. "I have an ear that is makin' a swell epaulet on my left shoulder."

They unload me and put me into a hospital that was once a Frog's swell summer home. Some officers come in and sit down in the operating room not far from where I am stretched out while a nurse fits my ear back against the side of my noggin."

"Do it fancy," I says. Hemstitches around the lobe, huh?"

"He's a little whoozy yet," the nurse says to a sawbones. "He won't need no knockout drops. You can start working with the needle."

**I** TRY to tell them I am in possession of my full senses but nobody believes it so go right on sewing me. Anyway a lot of things I hear from the next room is almost like ether to me.

"When a squadron starts cracking up, Henry," a brass hat says. "It goes fast. The Ninety-third is an example. Been up too long, I guess as even aviators have nerves, huh? Bagby will get the works all right. Left the drome flat at Commercy and him having his orders to be there to meet some officers from the Wing.

"They were going to give the outfit another trial, let them find themselves. The adjutant told the brigadier here that Bagby had to go to Bar-Le-Duc for some dental work. Why Bar-Le-Duc? There is a dentist in Commercy, and the army carries dentist chairs. He'd better show evidence of dental work when the benzine board sits. Hah!"

"Poor Bagby. Wonder what squadron that chap belongs to who waged a solo air offensive against the German air force. No concrete proof come in when I left Oscar. Heard it was a pilot named Hoolaly or something."

"Oh, yeah?" I cry out. You guys

knows everything huh? That was Lieutenant Ambrose Hooley of that wreck of a Ninety-third. And I am Spink who shot down a Zeppelin tonight. I also fly for Bagby!"

"Better examine him closer, Doctor," the nurse says. "He is ravin'. Zeppelins over this part of France, ha! The next thing he will report sinking a battleship."

"Yeah," the croaker says. "He's in bad shape, I fear. He might die on us."

"I will not!" I yelp. "I have got to get out of here. If I don't find out some things pretty soon, I will die, though. And don't let no more female nurses in here. Dames caused it all. Euphemia and Gladys—"

"Not much of a chance, huh?" the nurse says.

I show them what my chances are toot sweet by getting out of bed and asking for my pants.

"Amazing," a colonel says, coming out of the room where they amputate and set bones.

"What would I ask for, a camisole?" I snort.

"Let him go," the A.E.F. medico growls. "But get his name and address back in the U.S. as I want to write him up for a medical journal after the war."

I look at myself in a mirror and I scare me. My bad eye is worse than ever and looks and feels like a muskmelon. They have got my ear pasted against my dome with adhesive, and there is a lump on my dome as big as an Idaho prize spud. And my legs are in no shape for bicycling. I go out.

I ride to Commercy in a swell jalloppy that has worn out the whipcord seats of the best bass hats in France. I walk into the mess shack on the drome of the Ninety-third squadron, and there is Major Bagby sitting in a corner of the place holding his face in his hands. He has got a big gap in his dental assembly.

Ambrose Hooley is sitting in a chair

with his feet cocked up on another one and he is paring his nails. He looks at me nasty but says nothing.

"Look," I says. "It is me and I have not just come back from helping trim a booth at a church social. It is me, Muley Spink reporting for duty. I can explain most everything."

"What an eye, Spink. You look simply awful," groans Major Bagby.

**B**UGEYE nods to me.

"Glad to see you, Muley, even if not for long," he says. "The telephone has been ringing all day, and even Pershin' called and said what a great ace Ambrose is. All his confirmations have come in. He is askin' for a transfer to an outfit that is not on the blacklist."

"I am sittin' pretty," Ambrose says.

"You couldn't," I tell him. "No more than could a snapping turtle perched on a burnt stump. You start explaining things, you little nitwit!"

"Well, he almost got us, Spink," Bagby says. "I never knew a more vindictive man. Looks like he has got you. I fooled the creep. I got me a big rock and tied string around it. I put the other end of the string around a tooth and then dropped the rock out of the window. I will show them brass hats when they get here I was at a dentist's. I bored a hole in the good tooth too and colored it with tobacco juice."

"An eye for an eye," Ambrose says. "A tooth for a tooth. I got the tooth and almost the eye. You could lose that smoky lamp yet, Muley Spink!"

"Oh, so you *did* frame me out there, you little tomater!" I sigh. "Somebody tell me what happened, as I cheated death to get here to find out. After I know, I will not mind a court-martial."

"When you and I parted in Barley Duck, Spink," Bagby says. "I met Ambrose Hooley. He had landed his Spad outside of town, and I told him I would fix everything, him being so brave. So you see I didn't need your

motor-cycle to get back with, Spink. That is what I thought. Hooley gave me his word of honor to wait for me and fly me back. But when I got out there, there was no Spad and no Hooley."

"Then I *did* see the ape in Barley Duck," I says. "Oh, I thought he handed over that crate too quick. He saw right away you would get busted, and that I would too and so he let me have a crate that was being held together by threads. I would be a deserter."

"You are one," Ambrose says and has no more mercy than a starved wolf that has cornered a rabbit. "I said I would get hunk! Here I am in the driver's seat and waitin' for medals. Bagby had to give me a tooth to beat the rap an' you, well, I feel sorry for you, Muley Spink."

"Somebody give me a gun," I says. Just as the words are no sooner out of my mouth, a big mud-caked army boiler pulls up outside, the brakes squeal like Banshees. Two very important looking officers come in and one yells: "Is there a Lieutenant Spink here?"

"Yes, I am sorry to say," I says. "I'll go without a fuss."

"Congratulations, Lieutenant," a general says. "We know who knocked off that German Zeppelin now. An observation ship saw the skeleton of it just over the Jerry lines and it is still smoldering and so is the ammo dump it fell on and blew up. That Spad you crashed in. Had an alligator on it, wearing a derby. That was the one you flew last night, eh, Spink?"

"My crate," Bugeye says very thickly. Ambrose swears, and his peepers get as big and as round as two goldfish globes.

"That is the Spad I was flyin'," I says. "Ambrose here should know that. He lent it to me. How did—"

"You apparently were too muddled, Lieutenant, to have noticed the souvenir that dropped right into your cockpit," a brass hat says and then

hands me something. It is one of those heavy leather casques that Kraut gunners wear. On this one was printed in white letters:

H, KATTZHEIMER. ZEP. Z 24.

"Yeah," I says. "When the cigar blew up, I felt something drop into my office. It was quite a billiard shot I made, wasn't it?"

"See you have a tooth missing, Major," a colonel says. "Then you *did* have tooth trouble. Sorry about everything that's been said about this outfit. Two of your flyers ready to be decorated for heroism beyond the line of duty. Between them they smashed enough Hun morale to fill twenty box-cars. The squadron will be decorated, too, Bagby. Great outfit you have here."

"You will pardon me if I laugh," I says, looking at Ambrose. "It hurts me to, as when I do, this ear of mine gives a little."

"Remarkable, Spink," a general says. "How you knew that Zep was in this sector."

"I guess I am psychic," I reply. "As for you, Lieutenant Hooley, you crumb! How I wish I was a big fat pigeon for eight seconds as you would be no more. Excuse me as I wish to retire to my Nissan."

**I** AM in my hut testing my dome for cracks when Ambrose comes in. He is grinning like he had done nothing to me but put me up for his lodge back home.

"Hello, Benedict Arnold," I says. "Why don't you walk on your fuse-lage like any snake in the grass?"

"Look, Muley," Ambrose says. "If it wasn't for us gettin' on the outs and doin' big things while we was so sore,

this squadron would be all washed up now. You would not have smacked a Zepplin if I had not give you the Spad I stole from Bugeye, would you?"

"You are a lucky stiff, Muley. You would fall into a well with two anvils tied to you, and the anvils would turn to cork before you hit bottom. But as I says, it was team-work, Muley. Because you give me an idea to git in right with a nurse, I got arrested an'—"

"Oh, shut up. You can't smooth it over like that, Ambrose," I says sulkily.

"Awright, if you want to be that way, Muley. Now I won't let you in a big money-makin' proposition I have got."

"What."

"Major Bagby has a brother who owns a big soap factory in Keokuk, and Bagby has a big mortgage on it," Ambrose tells me. "The sales manager gets ten thousand a year and that is who I will be. You can be the star salesman."

"Huh? You do not know about soap. You hardly ever use it," I says.

"But I know about Gladys. Mrs. Bagby does not," Ambrose says.

I look very disgusted at Ambrose Hooley.

"You would stoop to blackmail, wouldn't you? Won't you stop at nothing?"

"Only a good estaminet," Ambrose says. "You will never get nowhere, being so squeamish about things, Muley. It was just an idea, is all. Well, I hope the Frogs wash their beards before we get decorated, Muley. The last time one kissed me, I itched for a week. Let us two heroes wipe up this chalk-line, Muley."

"Let's," I sniff. But I know it is another big mistake.

ANOTHER HOOLEY HOWLER

**DAWN PATROL WAGON**

COMING IN THE NEXT ISSUE

# The Ship of the Month

## THE NORTH AMERICAN FIVE PLACE ATTACK BOMBER NA-40C-A

**T**HIS is one of the Army's newest tri-cycle landing-gear Attack Bombers carrying a crew of five. The semi-monocoque fuselage is capable of carrying a bomb load of four tons in addition to the crew and machine-guns.

Two 1350 horsepower Wright Cyclone engines power this all-metal job with the honest, wide-open face and drag it through the upper levels at 308 miles an hour maximum.

Its normal cruising speed is 243 m.p.h. and even that speed is nothing to sneer at considering the load. The ship lands at 84 miles an hour. The North American's service ceiling is 25,400 feet. Its cruising range is 2650 miles.

The propellers are Hamilton Standard controllable pitch propellers of constant speed type. All wheels retract into the fuselage, making the swift, forward thrust of the ship as dragless as possible.

### SPECIFICATIONS:

Span .....	67' 6"	Weight empty ....	16,000 lbs.
Length .....	51' 5"	Weight loaded ....	24,000 lbs.
Height .....	14' 10"	Fuel .....	916 gals.
Wing Area .....	610 ft.		

### ENGINES:

Two Wright Cyclone GR-2600-A5B 1350 horsepower each.

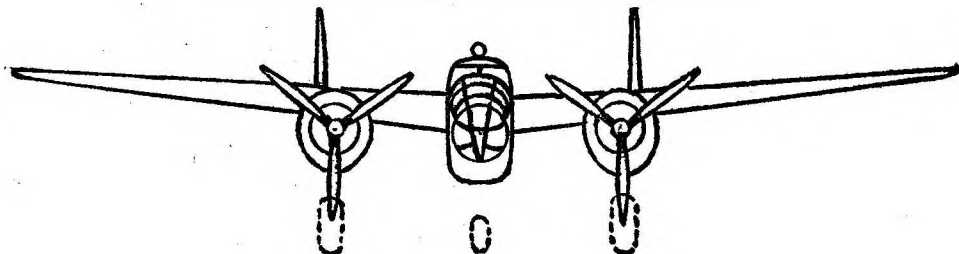
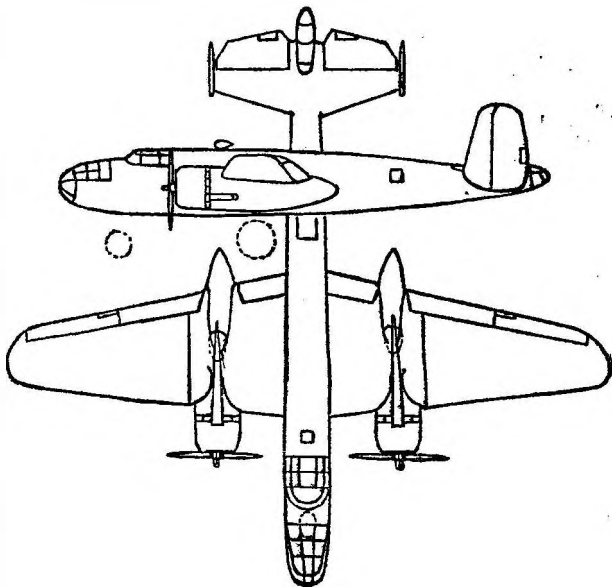

---

See it first in THE AMERICAN EAGLE

# Model Fighting Ships

## A Department of Accurate Brand-New Plans

### HOW TO BUILD THE NIEUPORT 17 C. 1

**T**HE Nieuport 17 C. 1 was a famous World War airplane which did much to keep the German ships from overwhelming the Allies.

In building this plane you will find that the lower plane is much smaller than the top one. The lower plane really was put there as a bracing member to give girder strength for the larger top plane. So keep this in mind if you feel it should look wider than the plans indicate. Some of the Nieuport single-seaters carried a Lewis gun on the top wing that fired over the propeller arc.

In this way the Nieuport helped the pushers combat the German synchronized Spandau gun when it began to blaze a bloody trail across the European war skies. When you build the Nieuport single-seater you are putting a plane in your hangar which can well be given a place of honor. It would still be a good little ship if a modern light-weight engine were installed.

In a recent issue we held forth on center lines in hope that it would help you model builders who already had not given this

easily fit into their places if the first two big lines are nailed correctly.

#### Materials

Balsa wood is the material usually used in model building. It is easy to shape, is light and is, for its weight, strong. The harder the wood the harder the job, so if you are not a past master in the art of shaping wood, stick to balsa. Piano wire for the wiring, which can be purchased at your model supply store, is far ahead of thread. It is rigid, doesn't collect dust and a light coat of varnish or airplane dope over wires keeps them from rusting.

An ordinary safety razor blade or a sharp knife will do your cutting. Fine sandpaper will finish the job. Coarse sandpaper can be used for some of the bigger shaping and for some builders will possibly be easier to handle than a knife or razor blade. Ambroid cement will hold the different parts together rigidly.

#### Fuselage

Already we have talked of the side view of the fuselage. Again we emphasize the importance of the top straight line and the bottom curved one. On the forward section of the fuselage notice the bulbous effect. This swelling is there to give sufficient space to house the engine.

Start at cross-section A with circular shape. As you shape back toward cockpit gradually flatten sides until just in front of cockpit they become flat, and continue so all the rest of the way back. The top of the fuselage is rounded from the nose to the tail gradually getting less of a curve as it nears tail. Cross-sections A, B, and C put this idea over. In rounding the top of the fuselage it is a good trick to make three flat surfaces, then go between them, cutting off the ridges until a nearly rounded shape is formed.

Sandpaper will take off the last high ridges and give you the rounded shape you desire. In doing the job this way you have more chance of getting it correct and not digging in too deep at any place with your knife or razor blade. Templates may be made for several points along the top. Cut from thin cardboard the shape of cross-section B and C. Make these shapes so they will fit down snugly on top of the fuselage when you have the curved top correct. Other templates may be made by guessing the curve at points between B and C.

In this way you can gradually cut down to the shape you want and have guides to fit down over the shape from time to time

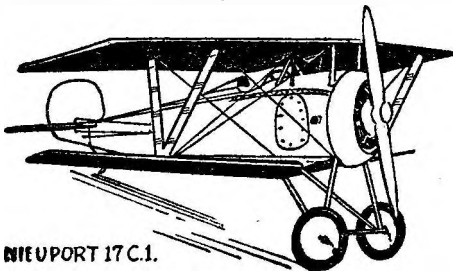

NIEUPORT 17 C. 1.

stunt serious consideration. We think that after trying out the system you will approve and will carry on with it in building your future models.

#### Let's Look at the Plans

Getting down to the business at hand let's take a quick look at the plans. First consider the side view. Notice that the general line of the top of the fuselage is straight and parallel to the center line. Now notice that the bottom line has a general gentle curve from the nose right on through into the rudder.

The other things that happen between these two lines are incidentals and will

#### Specifications—Nieuport 17 C. 1

Span.....	27 ft. 3 in.
Length.....	18 ft. 9 in.
Engine.....	110 h.p. Clerget

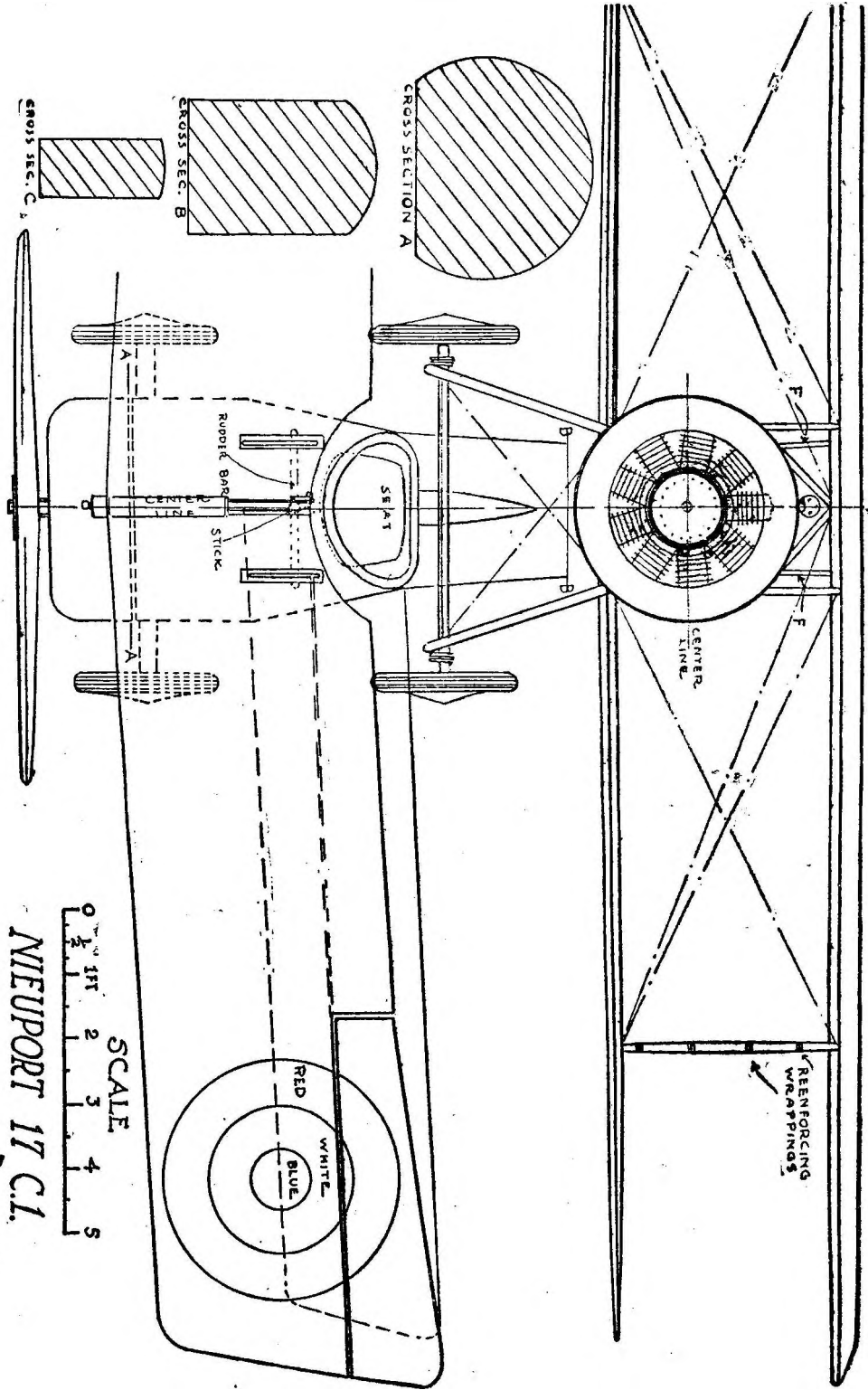



to show you the high and low spots and to warn you when you are approaching the end of your job.

The head rest behind the cockpit is easiest made in a separate piece and cemented to the finished fuselage before painting.

#### *Engine*

The power plant is a cylinder 110 h.p. rotary Clerget motor. Dowel wood used in furniture construction makes ideal cylinders. It is quite a job to put together this motor but if you want to try it the detail drawing of the nose gives all measurements. In making the round nose it is a good plan to make it separate from the main fuselage and cement it on.

If you make a motor it will be necessary to hollow out inside the nose. If you don't make separate motor, paint cylinders on flat front of nose.

#### *Cockpit*

Hollow out section for cockpit and place small seat and stick in position. Windshield is indicated in small perspective drawing only.

#### *Wings*

The top wing can easily be made of one piece of wood. First, cut an oversized piece of wood plenty thick and wide enough to get in the two back wing tips, then cut the front angle and next the back or trailing edges of the wing. In making the wing in one piece you get out of a glue job at the center section and your wing will be flat.

Shape the curve on top of wing from leading edge to trailing edge with coarse sandpaper wrapped around a small flat block of wood, finish with fine paper. The lower wings are made in two separate sections and cemented to the fuselage. Two pins with the heads clipped off, at each wing butt sinking half of each pin into wing butt and half into fuselage, makes for a firmer joint.

#### *Struts*

The end "V" struts are thick and husky. The center section struts quite thin. The two uprights at center section marked "F" are the rods running from cockpit up to cranks operating rods that run along inside of wings to actuate ailerons (see diagram). This crank arrangement is characteristic of many Nieuport planes both single and two-seaters.

It gave a definite fixed control of ailerons and a chance Beche bullet hitting any part of it couldn't sever it as a wire can be when hit.

#### *Undercarriage*

This part is simple. Use black thread to simulate rubber band shock absorbers. The undercarriage struts can be made of pine or any other hard or semi-hard wood. Do not use balsa for any struts. It is too soft.

#### *Tail Surfaces*

There is no fin to worry about on this model, only the rudder made in one piece. The stabilizer may be made separate from the elevator or both may be made in one piece and a line marked with black paint to indicate separation.

#### *Tail Skid*

A match cemented to a triangular shaped piece of balsa will be good for the skid. Bore a small hole up into the fuselage into which the match may be forced as it is cemented in place.

#### *Machine-Gun*

One gun in the center is used. In an earlier issue of THE AMERICAN EAGLE details on this gun were given. However, the dimensions of the gun shown in this set of plans for the Nieuport 17 C. 1 is to scale and you can get the big dimensions correct from it.

#### *Assembly*

If you have the last few issues of THE AMERICAN EAGLE you can get lots of tips on assembling your model. If you haven't or are a newcomer, here are a few for you:

Lay the fuselage flat on a board with pins and anchor it down solidly. Attach with ambroid, cement bottom wings placing small temporary blocks under extreme ends to get exact dihedral. Let cement set until thoroughly dry. Make two sets of scaffolding out of odds and ends to rest the top wing tips on, so dip wing is in exact position over fuselage. Now you can measure and make all struts to just slip in between top and bottom wings.

When you are sure of the strut's length and shape cement the center section struts into place. Let them set, then get the larger "V" struts on outer ends of wing in place. When all joints are dry, lock up the entire plane as you did top wing and attach undercarriage parts to fuselage in same manner wing struts were anchored into place. Tail assembly may now be cemented into place, also skid.

#### *Painting*

Never paint or enamel a model until all pores in the wood have been filled. Dope or shellac painted on in several coats will accomplish this. This filling keeps paint from sinking in and becoming dead-looking and lusterless. Sand lightly between each coat. Special airplane model paint, lacquer or enamel are good for the finished color job. Ordinary house paint will do, but it will take much longer to dry.

As to colors use your own judgment.

#### *Use Your Initiative!*

The main joy of model building is the satisfaction of making something with your own hands, of using your inventive initiative when you come up against the small details—of saying: "I built it myself. I did a good job." So, more power to you!

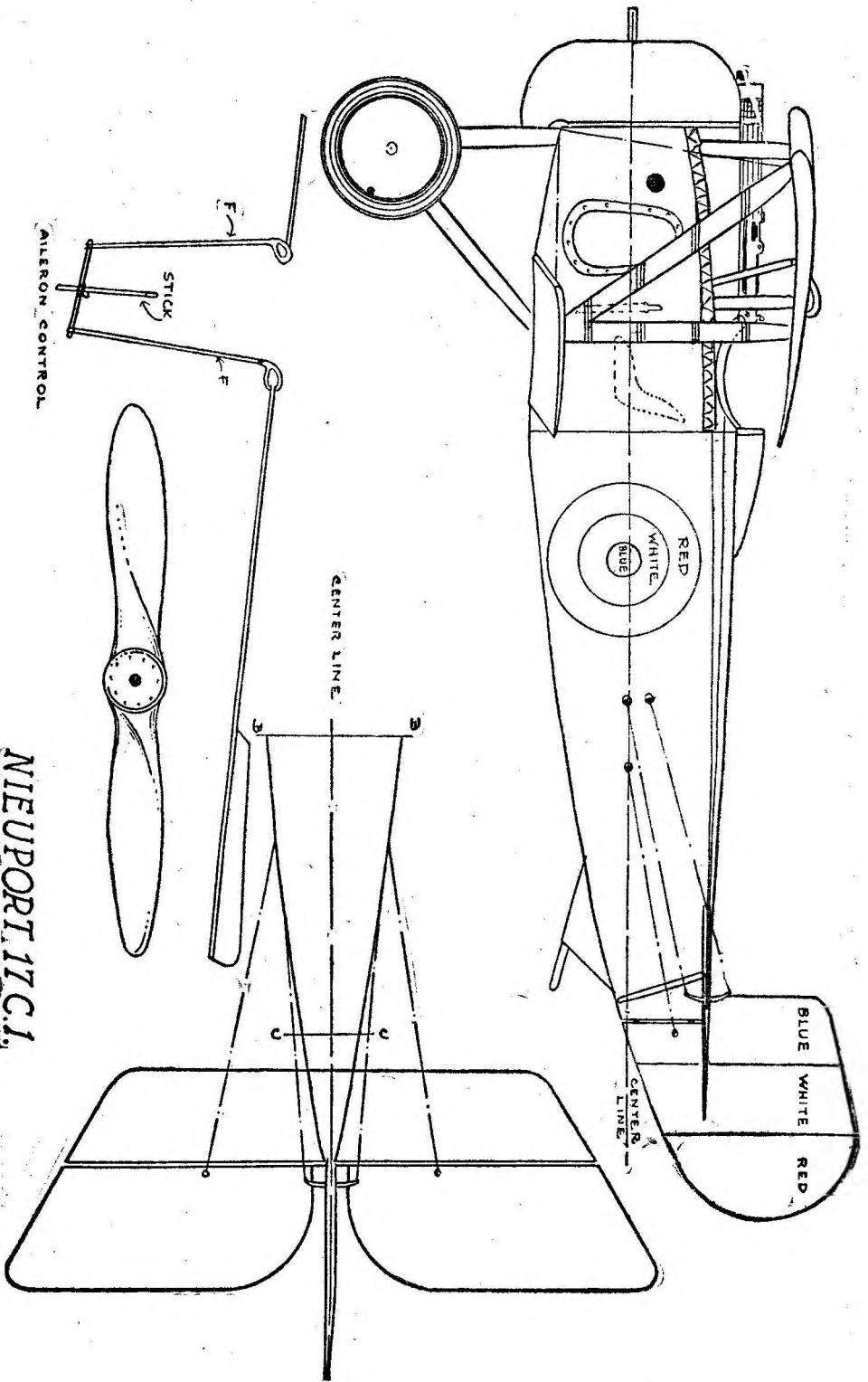

**NIÉPORT 17 C.1.**

# Murder's So Sorry

By LAURENCE  
DONOVAN

*Author of  
"Framed to Die," "I'm No Hero," etc.*

*Two American Air Instructors Run  
into a Welter of Grim Jap Strategy  
—and Battle to Beat the Sons of  
Nippon at Their Own Game!*

**T**OM MALVIN couldn't miss the murderous intent in the bombing of the U. S. Gunboat *Stralan*. He had been watching the Dornier, the triple-engined flying boat with the black and yellow rings of a deadly hornet painted around its twin-ruddered tail assembly.

"Some yellow stick-pusher who's

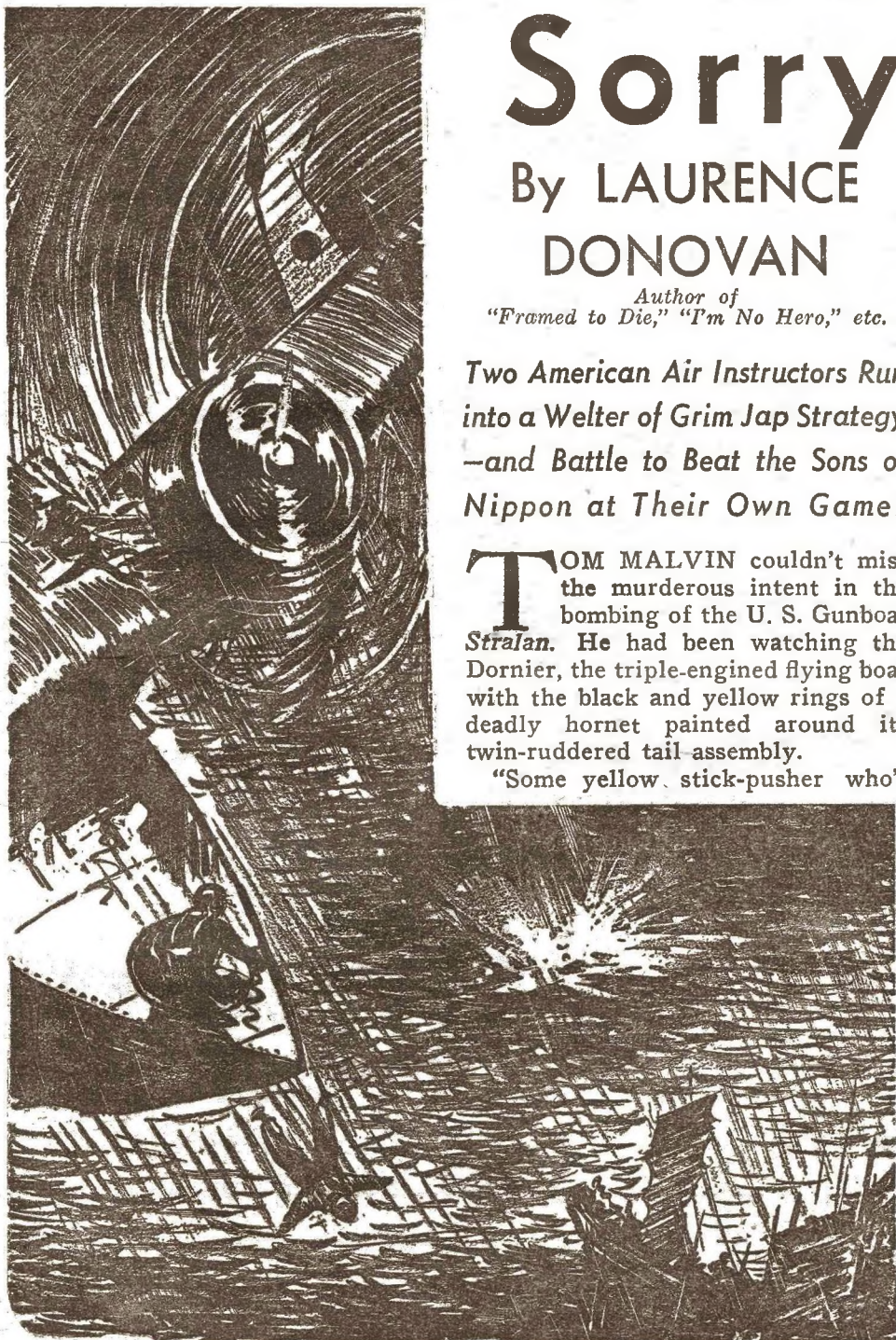

The three-engined Dornier became a wounded, dying bird—a great vulture!

got himself a proud record of killin' Chinese women an' babies in the rice paddies!" he said to Jeff Holden, just before the *Stralan* got it.

"Don't misbrand the guy," drawled "Long Jeff" Holden. "Them's mark-in's to show he's been in a dog-fight with some of the marines on the Shanghai waterfront. But look, Tom!"

For two weeks Tom Malvin and Long Jeff Holden had been seeing the Japs' five-plane patrol formation skirting almighty close to the international line in the troubled Gulf of Siam, a line unmarked, but understood.

The five Nipponese ships were undoubtedly German-designed bombers of the Dornier Do-24 class. They were easy enough for Malvin and Holden to identify, seeing both of them had been flying some of the same type crates in the Netherlands East Indies Air Force.

Only the plane of the flight leader carried the black and yellow hornet rings which, as Tom Malvin had observed, might mark a proud record of bombings among helpless Chinese.

The five-ship formation was low over the bay, and verging toward a shore where a mass of small junks and some fishing boats made a fogged shadow along the Siamese coast. Off to one side, its one cocky funnel spewing black smoke, the U. S. Gunboat *Stralan*, cruised at slow speed.

Long Jeff Holden's, "But look, Tom!" was the signal for all kinds of unexpected blasting to break loose. And, helpless in their small, hired launch, Tom Malvin and Long Jeff Holden saw all of it happen.

The five vultures of the Rising Sun gave no warning. Perhaps the flight leader wagged the wings of his hornet-tailed ship. The formation spread, and at barely a thousand feet one ship and another side-slipped and dived.

And one after another, at barely more than five hundred feet, the bomb racks were emptied. The Jap Dorniers themselves rocked in the explosions.

Whole sampans, portions of junks, bodies like mutilated dolls seemed to arise slowly, horribly, in the billowing yellow smoke of the close-ranged bombs.

**T**OM MALVIN stood erect in the cockpit of the rolling launch, his eyes hot and bitter, oaths streaming from his tongue, and his fists beating at the instrument panel of the launch until the skin was torn from his knuckles.

Behind him, Long Jeff was standing, swaying and swearing, his long fingers pulling at his hair.

It seemed to Tom Malvin he had been standing there for hours, watching the last of the toylike bodies falling from the yellow smoke and splashing into the bloody sea around the blasted shore craft, on none of which was there a single gun.

Then it was that Tom Malvin saw it—that sudden sideward dart of the flight-leading Dornier. Its yellow and black tail assembly was shining between him and the sun.

One, two, and three. The bombs slid from the Dornier's racks like that. Two went into the sea, straddling the U. S. Gunboat *Stralan*. The third never splashed.

"Jimmy! My God, Jimmy!"

Tom Malvin was unaware that the words were ripped from his lips. For he saw the cocky, smoke-belching stack of the Gunboat *Stralan* disappear. And Jimmy Durbin, who was to have been his brother-in-law was on that boat.

The gunboat could never by any stretch of the imagination have been classed as a warship. It had been a Mekong river steamer. Its conversion to neutral patrol duty had been accomplished by equipping it lightly with rapid-fire guns fore and aft, and half a dozen machine-guns. Its American colors were prominently displayed.

There was no armor to resist the bomb that clipped out its stack and



neatly tore out its machine inards. The boat started sinking slowly, but grounded, and lay broken in the shoal water.

Even before the third bomb had exploded, the Jap Dornier with the yellow and black tail had slipped to one side. As the smoke cleared, the five yellow assassins of the Rising Sun again were in formation.

Led by the hornet-tailed patrol bomber, the worthy killers displaying the emblem of the Rising Sun faded from view in the general direction of Saigon or Camranh Bay, at either of which they might have been based. . . .

Tom Malvin and Long Jeff Holden piloted their heavily laden launch to the decks of the bombed Gunboat *Stralan*. There they were helped to unload some of the human cargo they had collected floating in the sea.

Some of the swimming crew they had picked up were alive and unhurt. Others were unconscious from deep, bleeding wounds. Two need never have been picked up at all.

And it was beside one of these two that Tom Malvin knelt with tears streaking the smoke and dirt gumming his cheeks.

"Jimmy!" he whispered. "Jimmy, what am I going to tell Martha? Jimmy, Long Jeff an' me jumped the base an' come all the way across to say 'hello.'"

Gray-haired Captain Carsten stood beside Tom and Long Jeff.

"He's one of seven," said Captain Carsten. "I've made out my report, but there isn't much can be done about it. You, Malvin and Holden—it'd be best if you get back to your base an' don't talk too much. There's no way to prove it was other than an accident, the Japs missing our colors perhaps in the smoke."

Tom Malvin whipped to his feet.

"Jimmy Durbin here was to have married my sister," he said. "I have the job of explaining to Martha how I saw him die. That bombing wasn't an accident. Not any more than

the machine-gunning of the old *Panay* a few years ago. And by all that's holy—"

"Easy, Malvin!" The hand of Captain Carsten was on his arm. "It all happened too quickly for any of my own men to be sure that we weren't mistaken for some of the Siamese or Chinese boats. You and Holden are absent without leave, and your word would only create an international incident."

"International mess be blowed!" shouted Tom Malvin. "Sure, we are here without leave! All we're doin' anyway, is teachin' some of the Malaysians how to shoot the heck out of a floatin' wind sock, which none of 'em ever will! So I'm personally going to—"

"YOU will, for your own good, forget what you have seen," Captain Carsten interrupted firmly. "So far as it can be officially determined, the Japanese in a general bombing of Chinese and Siamese river boats, mistook the *Stralan* for other than an American vessel. It does look Chinese, you know."

"You mean you're not going to raise merry heck and demand the punishment of the blasted yellow murderers of Jimmy Durbin and these others?" exploded Tom Malvin.

"Certainly I shall demand justice," said Captain Carsten. "And just as certainly there will be official communications, and probably an apology. Unfortunately, as much as I would like to do so, I cannot personally go after the killers. Officially, I have no witnesses to prove that the bombs hitting my boat were dropped intentionally."

"Well, I'm a witness, and I say they were!" flared Tom Malvin. "I know which plane, and I can get the pilot!"

"It's too bad, Mr. Malvin and you, Mr. Holden, that you are at present attached to a British flying unit, and that both of you are on this side of the

bay without leave," stated Captain Carsten. "Unfortunately, too, the international situation is such that the whole matter must take its routine course through Tokyo and Washington."

Tom Malvin's eyes were suddenly bleak and hard.

"That's what you think, Captain Carsten," he said angrily. "The dirty yellow killers will say it was all a mistake, and the Tokyo government will say it is so sorry . . . Come on, Long Jeff! Let's get out of here!"

\* \* \* \* \*

Captain Jamison, the C.O., had Tom Malvin and Long Jeff Holden in his baking office. It was a small cubicle of sheet-iron close to a camouflaged hangar. All of the base was little more than a runway hacked out of the Malay Peninsula jungle.

Although British, Captain Jamison had a sense of humor. It was essential in this isolated Malayan air base where some fifty native seekers after war wings were being trained.

In the beginning, these natives could not have driven an automobile on a straight, broad road. Yet today nearly all of the beginners could handle their special Ryans, the latest American plane being used to train hundreds of new pilots in the vital islands. And some of the native pilots could sometimes find the wind sock target with the tracers from their Brownings.

**CAPTAIN JAMISON** was holding a flimsy bulletin sheet, as he appeared not to notice the grim lines on the faces of Malvin and Holden, his two Yankee instructors.

"You may be interested, Mr. Malvin and Mr. Holden, in the conclusion of the recent incident of the Gunboat *Stralan*," said Captain Jamison. "Officially, I am not aware that you know much of the Japanese bombing of the United States gunboat. Unofficially, I'll say that I am sorry how it concerned you intimately."

Tom Malvin nodded, and said merely, "Yes, sir." But there was smoldering trouble in his eyes as he glanced at the flimsy report in the captain's hand.

"We have this bulletin concerning the Gunboat *Stralan* incident," said Captain Jamison. "The Imperial government at Tokyo deeply regrets the accident which resulted in the loss of the United States Gunboat *Stralan*, and expresses the deepest sympathy in what must be regarded as an unavoidable tragedy. Suitable reparations will be made to the government of the United States."

Tom Malvin's fingernails dug into the palms of his hands. Long Jeff Holden's shoulders stiffened to an unaccustomed erectness.

"Yes, sir," said Tom Malvin through clenched teeth.

But Captain Jamison laid aside the flimsy.

"Of course," he said, "this closes the incident. Therefore, any vague reports I may have heard concerning utterances on the part of you, Mr. Malvin, and you, Mr. Holden, must herewith be considered without any foundation in fact."

Tom Malvin's blue eyes were level with those of the C.O.

"You have heard, sir, that I have said I will get the yellow devil who killed Jimmy Durbin," Tom said evenly. "The report that the incident is closed only makes my intention all the stronger. The blowing up of the *Stralan* was direct murder, sir."

Captain Jamison pulled one finger across his clipped mustache.

"Do I understand, Mr. Holden, that you share Mr. Malvin's opinion?" he said.

"You're blessed well—I'm sorry, sir," said Long Jeff. "I mean, yes, sir. I go along with Tom."

"It would be inconvenient to lose the two best instructors the unit has ever had," Captain Jamison said soberly. "However, I cannot have two pilots who admit they are prepared to



start an undeclared war on their own. It leaves me in one deuce of a hole, although I cannot say that I hold it against you."

Tom Malvin spoke up quickly.

"Speaking for both of us, sir, we will give our word there will be no shooting whatever. We would carry on as before, sir, and I would suggest that our own plane, when on target or other training duty, shall carry only unloaded guns."

A puzzled expression came over Captain Jamison's blunt features. During past weeks he had learned something of the hot-headed American, Tom Malvin, and his slower but equally stubborn flying partner, Long Jeff Holden.

"That is quite extraordinary, Mr. Malvin," said the captain. "I would not consider it necessary, if I can but have your word that you will remain strictly neutral and not in any way seek to carry out an attack upon the Japanese or other potential enemies."

"We would prefer the unloaded guns, sir, and you have our assurance," stated Tom Malvin. "Shall we continue practice as usual?"

"You may carry on, Mr. Malvin and Mr. Holden," said Captain Jamison.

He had been given the assurance he had sought, but as the pair of trim, quick-moving American fliers disappeared into the concealed hangar, Captain Jamison pulled at the corner of his mustache.

"Now what in the *dévil* do you suppose those two Yankees are keeping from me?" he said softly. "That business about the unloaded guns is a bit too much on the balmy side."

\* \* \* \* \*

**T**OM MALVIN gave the Hispano-Suisa engine full throttle. He slanted the nose of the Koolhoven FK-58 at a bank of cumulus clouds. In its time, this training plane of the East Indies and British Malay had held the world's diving record.

Tom Malvin pushed it to its quick climbing capacity of three thousand

feet per minute. In the cockpit behind him, Long Jeff Holden looked to the reel of stout manila line attached to the folded target sock.

A dozen native trainees were pegging about in their slower Ryan training ships, equipped especially with both fore and rear cockpit Brownings. The natives were slow to get the feel of their ships, and slower still to adjust themselves to accurate shooting when peeling from formation in a dive.

At five thousand, Tom Malvin searched the edge of the cloud bank. Although the Koolhoven mounted six guns, Tom Malvin had insisted that their drums be emptied.

"Might as well shake out the sock, Jeff," said Malvin. "This is one heck of a way to be spending a war. The boys we've got up could come closer to pegging the sock with throwing spears than with lead. All right, ripple it out!"

Malvin leveled off, then glided to around four thousand. He cut the throttle to match the slower speed of the Ryans, gave the Koolhoven a wig-wag, and the dozen Ryans bunched into awkward formation that caused Long Jeff to grunt with disgust.

"How the heathens keep from rubbin' wings is beyond me," he complained. "Look at that collection of misfits! When they form a V, it might be any other letter in the alphabet!"

Tom Malvin lifted his hand and barked into the radiophone connection to the flight leader of the mismatched formation.

"All set! Widen your line! And be sure you wait until the ship on the sock has cleared before the next one peels off!"

The elongated wind sock of heavy canvas drifted back of the Koolhoven on a hundred, then two hundred yards of unreeled line. One of the Ryans peeled off and thundered down with tracers smoking.

Long Jeff snorted with disgust. It was plainly evident that the native

pilot was making sure that he would not entangle with the floating target sock.

Another Ryan peeled off, and another trainee sent tracers smoking far behind the sock as he took his dive, then pulled out of it too short.

Long Jeff kept up a running fire of abuse directed at the ineffectiveness of the target practice. But Tom Malvin was not hearing any of it. He was silently repeating words to himself:

"Remain strictly neutral, and not in any way seek to carry out an attack upon the Japanese or other potential enemies—"

His eyes were fixed upon the shining edge of the banking clouds. He was glancing occasionally at the dancing gulf below, the Malay Peninsula bordering it, and at the sky.

"Right along about here," he muttered softly. "For two weeks they edged the middle of the gulf at five thousand, then they blasted the Siamese and the Gunboat *Stralan*. And every day for a week since then they have followed that same line of patrol."

Back of him he could hear the diving thunder and the staccato chatter of the Ryans' target salvos. But Tom Malvin kept his eyes fixed higher up, following that rising rim of cumulus clouds.

"Every other day they came over the sky was clear." Malvin was muttering again. "But today, if they hold to the same bearings, we'll get a fast five or six hundred ceiling under that storm."

**I**N HIS mind Tom Malvin was seeing what he had been thinking about every waking hour, and dreaming of at night. He could see the yellow and black rings around a tail assembly with twin rudders, the Dornier that had led that bomb massacre.

And each time he saw that yellow and black hornet's tail, he could also see the bruised and bloody face of

Jimmy Durbin. The bruised and bloody dead face of Jimmy Durbin, about whom Martha now must know, for the newspaper had carried the names of those who had died in that—

"Regrettable incident."

"What, Tom?" queried Long Jeff, and Malvin realized that he had shouted the words.

Tom Malvin pushed the Koolhoven up and up this time. The flight leader of the training natives protested over the phone.

"Shootin' won't always be on the ground level!" Malvin snapped back. "See that cloud bank rolling up? Well, Mister, we're doing a drag right along its edges! Now see if they can peel off and find the sock when they can't see it!"

The flight leader of the practice ships started another protest. To his surprise, Tom Malvin's voice cracked into his ears.

"Okay, Mister! Get your boys down! The shootin's all over for the day! Get 'em down, I said!"

Long Jeff heard the abrupt and unexpected order. He was watching the target sock trailing far behind. It was lying close along the white and purple folds of the first of the rolling storm.

"Bring 'er in, huh?" said Long Jeff, and started to turn the reel.

"Stop it, Jeff! Let 'er ride! Get set and be ready to bale out! We're going up!"

Tom Malvin had seen them. The Japanese flight of five, the Dornier patrol. The yellow and black of the rings on the leading Dornier's tail seemed to burn through his eyes into his brain.

One hand went out and instinctively gripped a trigger. And he was glad he had insisted upon empty guns.

There they came, that parade of yellow murderers. Flashing along the rim of the storm clouds.

"Ready to blast more women and babies," grated Tom Malvin. "Never once has a single yellow devil of them known what it was to have a man-to-

man, wing-to-wing fight, or to risk death as a pilot should expect. Never a fighter there. Only killers of the unarmed and the helpless!"

Long Jeff stared at Tom Malvin then. Malvin was pouring everything into the Hispano, reaching toward the high cloud bank so steeply that the Koolhoven seemed to be suspended by its single thundering prop.

Long Jeff glanced back, just as the ship dived from daylight into the cold, misty darkness of the storm. And he saw the target sock whipping about crazily.

Tom Malvin had never flown a ship with a nicer degree of calculation. For as he had pushed the plane into the edge of the cloud bank, he had estimated air speed and wind direction, and the moving position of the Dornier patrol formation now below him.

He could feel the static crackle of storm lightning rippling along the instrument panels. The Koolhoven was capable of twenty-four thousand. Malvin glanced at the altimeter and it was reading fourteen thousand. There was some pressure on his ribs and throat, and a whiff from an oxygen nipple would have helped.

**H**E COULD not exceed eighteen thousand without special altitude tanks. Yet, as his mathematical mind had diagrammed the next few minutes of flying, he desired nearly to touch that height.

Now he was out of the storm, with the late afternoon sun blazing. The clouds rolled below like a black-billed sea. Long, jagged streaks of lightning ran through it.

Long Jeff touched his shoulder.

"We're wallopin' the daylight out of that target sock," he said. "Whatcha mean about bein' ready to bail out?"

"Just be ready, that's all," said Malvin grimly.

His eyes were upon every drifting break of the storm clouds below.

"The yellow sons are now at their usual turn," he said, checking his

time. "And they're gettin' a beltin' from that rain. Okay, Jeff! Hang onto your left ear!"

Once the Koolhoven had held what was then a diving record. That was back in Nineteen Thirty-eight before air speed maniacs instead of plane designers had been introduced into the war plants.

Anyway, this was good enough for Tom Malvin's tortured spirit. The Koolhoven passed three hundred m.p.h. on the air speed indicator. He could envision that target sock whipping behind like the cracking tip of a rawhide whip.

As he rode the thundering air, slashed through the storm clouds, and smashed into the rain with a ceiling of scarcely more than a thousand feet, a wave of exultation flooded through Tom Malvin. No doubt he had miscalculated some on his day-by-day check of the routine of the Rising Sun patrol bombers, or the slashing rain and the low ceiling might have moved the yellow sons of Imperial and apologetic murder a few degrees one way or the other.

But Tom Malvin yelled with a fury that made his voice heard even above the thunderous din of his own strained prop and motor. For there they were! The five Dorniers. The yellow and black of the flight leader now was obscured by the slashing rain, but the planes were outlined like prowling, shadowy vultures.

"'Regrettable incident!'"

Tom Malvin screamed it out. Long Jeff hunched, braced himself, for to his slow mind it had come suddenly that Malvin intended smashing into and through that Rising Sun murder flight of five. Yet no warning came to Long Jeff Holden to bail out. At that height and at that diving speed, it would have been suicide anyway.

Tom Malvin played the controls of that roaring comet with the sensitive skill of a violinist. Under him were the five closely V-ed Dorniers, and with the suddenness of a gun flash in

the darkness, Malvin's vision registered the rings of yellow and black on that flight-leading yellow assassin of the sky.

"Jimmy, boy, here's lookin' at you!"

Long Jeff heard the crazily uttered speech as though Tom Malvin were proposing a toast—and he was. A blistering toast of death to the yellow killers of the Rising Sun.

Long Jeff closed his eyes and opened them again. His stomach bounced into his throat, leveled off, and his nearly collapsed lungs sucked in air. For the Koolhoven was straining its wings to the breaking point as Tom Malvin came out of that incredible dive.

Malvin's eyes whipped around. He saw the stout line on the target sock reel snapping as if it were some angler's line that had suddenly connected up with a fighting monster of the sea. Then that line almost tore the reel from place. The plane rocked and side-slipped. Tom Malvin looped upward into the rain. Fighting the downpour, feeding the Hispano the last ounce of power it would take, once more he was virtually hanging the ship on its tortured prop.

There, for perhaps ten, or perhaps twenty long seconds, Tom Malvin's speech was frozen in his throat. Long Jeff crouched beside him, trying to see more clearly through the rain-swept plexiglass of the window.

A three-engined Dornier, with yellow and black stripes around its twin-rudder tail seemed to have become a living bird. But it was a wounded, dying bird, a great vulture, the power of its wings abruptly paralyzed.

Yards of stout line were caught and wound tightly around the wounded Dornier's middle prop. A flapping, rain-sogged, canvas target sock literally ripped another prop from its place, tearing out the motor for good measure.

Tom Malvin could picture the yel-

[Turn page]

## Spare Time Training that helps you **SERVE and PROSPER** in this national crisis

**YOU** want to serve your fullest in this Defense situation, do your utmost to help our nation. You want also to advance yourself in position and pay—win promotion and more money.

You can do both at the same time.

Our nation needs many more men for specialized and supervisory positions—to help defense production and business growth. Thousands—scores of thousands—must fit themselves quickly for these better paying jobs in offices and stores and factories. They must train as accountants, salesmen, managers, foremen, traffic managers, general foremen, office managers, inspectors, etc.

If you wish this advantage, simply mark on the coupon the field of business in which you are most interested. We will send you full information about the opportunities in that field, tell you how our complete success-building program helps you plan your future, trains you in your spare time, and works with you all through your career. Send the coupon NOW.

### LASALLE EXTENSION UNIVERSITY A Correspondence Institution Dept. 12329-R CHICAGO

Please send me full information regarding the success-building training and service I have marked with an X below.

- Business Management:** Training for Official, Managerial, Sales and Departmental Executive positions.
- Modern Salesmanship:** Training for position as Sales Executive, Salesman, Trainer, Sales Promotion Manager, and all positions in retail, wholesale or specialty selling.
- Higher Accountancy:** Training for position as Auditor, Comptroller, Certified Public Accountant, Cost Accountant, etc.
- Traffic Management:** Training for position as Railroad, Truck or Industrial Traffic Manager, Rate Expert, Freight Solicitor, etc.
- Law:** LL. B. Degree.
- Modern Foremanship:** Training for positions in Shop Management, such as that of Superintendent, General Foreman, Foreman, Sub-Foreman, etc.
- Industrial Management:** Training for Works Management, Production Control, Industrial Engineering, etc.
- Modern Business Correspondence**
- Expert Bookkeeping**
- Commercial Law**
- C. P. A. Coaching**
- Stenotypy**

Your choice of these booklets Free. Ask for one.

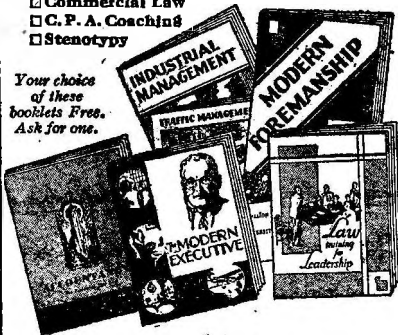

Name..... Age.....

Present Position .....

Address .....

low face of that murder pilot who had so casually bombed the Gunboat *Stralan*. He could vision the faces and the eyes of the crew with him, trapped too far down to bail out, and being whirled around in what had become a coffin of chaos.

Perhaps Tom Malvin had entertained but slight hope that more than the yellow and black bomber would be downed. But that Jap formation was close. That target sock slapping out of the rain to send the flight leader's crazy boat bucking and stalling caught two other pilots unprepared.

The flying boats were cumbersome ships. Originally intended for island transport, then converted into short-range bombers, they were about as maneuverable as flying garbage scows.

Tom Malvin circled low. Fire smoked up from the water. A surprised pilot had neglected to switch off the ignition. The bay boiled from the smash of weight, but no heads of swimmers appeared.

Malvin glanced at the calming water. He looked up at the fast fading storm clouds. Two distant dots there were departing planes, pilots of the Imperial government of the Rising Sun, returning to base to report.

Tom Malvin's right hand raised stiffly.

Long Jeff said nothing. He realized that silent salute was for Jimmy Durbin. . . .

**CAPTAIN JAMISON**, the C.O., held a flimsy bulletin in his hands. Again he had Tom Malvin and Long Jeff Holden in the sheet-iron oven he called his headquarters. He

stroked his clipped mustache and kept his eyes upon the paper in his hands.

"I have received this news from London, gentlemen," he said quietly. "I thought you might be interested in the conclusion of certain correspondence between London and Tokyo and Washington. His Majesty's government, after full investigation, apologizes and expresses its deepest regret for the tragic incident in which one Tomura, a noted flyer of Japan, and others lost their lives.

"Complete reports exchanged between the capitals fully exonerate the British government in the unavoidable accident whereby three patrol planes of the Imperial government of Japan were lost with all on board as the result of the apparent poor judgment of Pilot Tomura. It is stated that Pilot Tomura lost control of his plane after a British training ship piloted by Thomas Malvin had been expertly maneuvered to avoid a collision in the blindness of a sudden storm. The British government expresses the deepest sympathy for what was an unavoidable tragedy."

Captain Jamison folded the flimsy bulletin carefully.

"Mr. Malvin and Mr. Holden," he said quietly, "officially I desire to congratulate you upon the implied praise for your flying judgment contained in the government report."

Captain Jamison caught his clipped mustache briefly between his teeth.

"Unofficially, strictly off the record," he said, "you made one bully job of a wholly unregrettable incident."

Tom Malvin said merely, "Yes, sir. Thank you, sir."

True Picture-Stories of the World's Greatest Heroes in

## **REAL LIFE COMICS**

64 PAGES OF TRUE AND GRIPPING ACTION!

Now on Sale

**10c**

At All Stands

## AROUND THE HANGAR

(Continued from page 13)

one from Jack McCain, Perry, Kansas. Jack comes in handy as get all of this:

I am fifteen years old and have been reading your mag ever since before World War II started. Please enroll me as an American Eagle and as a pen pal.

I heartily agree with Warren Miller and his opinions. I think L. T. Scott Morgan and Joe Archibald as writers are tops. Keep sending us more stories from them and keep John Masters in the present war.

And still they join up. How can Hitler possibly win in the end? The customer is always right, we've heard, so we have to pass Jack's compliments on the Morgan and the little guy who eats cigars longer than his right arm, Joe Archibald. One more boost for those two writers and we will not be able to live with them. Morgan hit big time a few weeks ago and he walks around like he owned the joint.

Oswald, who is helping us with the mail, looks like he is close to a stroke as he hands us a letter and he says maybe we should have a showing of hands here in the hangar before we let it go to the printers. We read the thing over ten times and so we give it to the readers for digestion. The bi-carb is over on the shelf, everybody. Hold onto your hats and remain calm now even in the face of this grenade from a Jean Le Commer who gives his address as a "Western Penna. town."

Many of your ardent readers are having a dispute as to where to put J. Masters. In World War I or II. Why not compromise and put him in the gutter where he belongs? If it wouldn't be too much bother for you, do the same for the rest of those who are getting excited over their hero, John Masters, the madman of the skies.

No matter what John Masters does (with the aid of the entire staff of THE AMERICAN EAGLE magazine) the German nation will remain invincible.

If any of you readers doubt this, consult the World Almanac and read for yourself the futile battle the Norwegians, Belgians, Poles, Danish, Dutch, French, Greeks and British have put up. The glorious retreat of the British at Dunkirk, Salonika, and Crete shows the mighty R. A. F.'s striking power. Where were those heroes of yours who could bring down a German plane with a short burst in ten seconds of battle? In your magazine the German planes can be brought down with a short burst while a German pilot must use all of his ammo on one British plane.

This nation was supposed to be neutral, but since 1919 these aviation magazines which are sold to these air-minded suckers have blasted the German army, navy, and air force to pieces unceasingly. Yet the German nation is existing. And you call that neutrality?

Don't you think this madman of the skies should come down to earth and be a human once more instead of putting silly ideas in the minds of the readers?

Here's to R-47—may she be lucky enough to kill this American Eagle and put an end to this nonsense which you print.

All criticisms will be answered if you print this, which I hope you will.

If the above diatribe against law and order was cooked up to get a rise out of this poor old war vet, then the citizen who was loath to send his address, succeeded, as we went up so high the pate of our worried noggin took a chunk of plaster off the ceiling.

Jean Le Commer! French? Things do  
[Turn page]

# MECHANICS

KNOW  
YOUR  
CAR

You Need  
this  
Book

JUST  
OUT!

NEW FLUID  
DRIVE FULLY  
EXPLAINED!

Ask  
to  
See it!

A  
USEFUL  
XMAS  
GIFT



Every operator and mechanic needs AUDEL'S NEW AUTO GUIDE. This book saves time, money and worry. Highly endorsed. It presents the whole subject of auto mechanics: 1—Basic principles, 2—Construction, 3—Operation, 4—Service, 5—Repair. Easily understood. Over 1500 pages—1540 illustrations showing inside views of modern cars, trucks and buses with instructions for all service jobs. Diesel Engines fully treated, fully illustrated. To Get This Assistance for Yourself Simply Fill in and Mail Coupon Today.

**COMPLETE • PAY ONLY \$1. A MONTH**

THEO. AUDEL & CO., 49 WEST 23rd STREET, NEW YORK  
Please send me postpaid AUDEL'S NEW AUTOMOBILE GUIDE (\$4) for free examination. If I decide to keep it, I will send you \$1 within 7 days; thereafter I will pay until purchase price of \$4 is paid. Otherwise, I will return it to you promptly.

Name \_\_\_\_\_  
Address \_\_\_\_\_  
Occupation \_\_\_\_\_  
Reference \_\_\_\_\_ PAL

**SAVE UP TO 50%  
FACTORY-TO-YOU**

**9 BANDS  
(ON 5 DIAL SCALES)**

**30 DAYS TRIAL**

**20 TIMES BETTER FOREIGN TUNING**  
with SUPER BAND SPREAD RADIO!

**EMIT THERM CHASSIS IN  
WOODEN RESONANT CABINETS**

**UP TO \$50.00 TRADE-IN**

**WRITE for big FREE catalog, New 1942**  
models include Radios, Radio-Phonos,  
Home Recorders. Sensationally low  
factory-to-you prices: \$12.95 to \$212.50.

**\$19.95 COMPLETE**

**16 TUBES (Uzor-Aperts Wanted)**

**MIDWEST RADIO CORPORATION**  
DEPT. 625 CINCINNATI, OHIO

**DRAFTING**

**MORE DRAFTSMEN NEEDED** in all manufacturing and building lines—\$30 to \$50 a week and UP. Learn quickly at home in spare time. Selection Employment Service. Write NOW for FREE Bulletin. No obligation.

**American School**  
Dept. DD958, Drexel & 58th, Chicago

**FREE!** \$99 Full Size  
FOOD & HOUSEHOLD  
PRODUCT ASST.

Send No Money! Rush name and address for big Assortment of FOODS, GROCERIES, SOAPS, Etc.—full size packages worth \$5.00. **ABSOLUTELY FREE!** Show these products to friends, neighbors. Take orders for sensational values, more than 300 quality products used in every home. No shortages—sure deliveries. Earn big profits, full or spare time. No experience necessary. Write for FREE \$5.00 Assortment of Products NOW. ZANGL 3874 Monmouth, Cincinnati, O.



# MAKE YOUR OWN RECORDS AT HOME

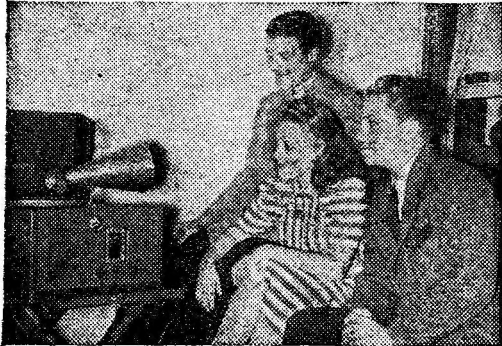

Charlie Barnet with Judy Ellington and Larry Taylor, vocalists in his band, listen to a record they just made with Home Recorder.

Now a new invention permits you to make a professional-like recording of your own singing, talking or instrument playing. Any one can quickly and easily make phonograph records and play them back at once. Record your voice or your friends' voices. If you play an instrument, you can make a record and you and your friends can hear it as often as you like. You can also record orchestras of favorite radio programs right off the air and replay them whenever you wish.

## Find Out If You Have Professional Talent

The movies . . . radio . . . stage in both Broadway and Hollywood are ever seeking new talent.

Before spending money for an audition, make a "home record" of your voice or instrument and mail it to a reliable agency . . . you might be one of the lucky ones to find fame and success thru this easy method of bringing your talents before the proper authorities.

## IT'S LOTS OF FUN, TOO!

You'll get a real thrill out of home recording. Surprise your friends by letting them hear your voice as though it were broadcast. Record a snappy talking feature. Record jokes and you will become the life of the party. Great to help train your voice and to cultivate speech . . . nothing to practice . . . you start recording at once. No other mechanical or electrical devices needed. Everything necessary included. Nothing else to buy. Just sing, speak or play and HOME RECORDER unit which operates on any electric or old type phonograph will do the recording on special blank records we furnish. You can immediately play the record back as often as you wish. Make your home movie a talking picture with HOME RECORDER. Simply make the record while filming and play back while showing the picture.

THINK OF IT! I JUST MADE THIS RECORD WITH THE NEW HOME RECORDER!

IT'S WONDERFUL AND SO SIMPLE - PLEASE LET ME MAKE A RECORD.

**OPERATES ON YOUR AC OR DC ELECTRIC PHONOGRAPHS RECORD PLAYERS RADIO-PHONE COMBINATIONS Old or New Type PHONOGRAPHS and PORTABLES**

## SEND NO MONEY! HURRY COUPON!

Everything is included. Nothing else to buy and nothing else to pay. You get complete HOME RECORDING UNIT which includes special recording needle, playing needles, 6 two-sided unbreakable records (equivalent to 12 records). Also included guide attachment combination recording playback unit suitable for recording a skit, voice, instrument or radio broadcast. Additional 2-sided blank records cost only \$.75 per dozen.

**COMPLETE OUTFIT \$2.98**  
INCLUDING SIX TWO-SIDED BLANK RECORDS, ONLY

HOME RECORDING CO., Studio KO  
9 East 19th Street, New York, N. Y.

Send entire HOME RECORDING OUTFIT (including 6 two-sided records) described above by return mail. I will pay postman \$2.98, plus postage, on arrival. (Send cash or money order now for \$3.00 and save postage.)

Send..... additional blank records at \$.75 per dozen.

Name.....

Address.....

Note: Canada & Foreign, \$3.50 cash with order.

not add up unless you were one of the citizens who forgot to blow up the bridges in Northern France when the Krauts burst through Sedan.

Why not give us your correct address as we are sure that thousands of young American aviation enthusiasts will want to get in touch with you. And we do mean you, M'sewer! The R. A. F. is doing all right now, pal. They'll keep on doing it.

About our madman, John Masters—but let's talk about a real madman. How could any self-respecting country remain neutral after the wholesale slaughter at Warsaw and Rotterdam, pal? Don't the ghosts of thousands of dead bother you when you sleep, M'sewer? They bothered Rudolph Hess, we imagine. Pardon us if we take time out here to try and get a bad taste out of our mouth. Oswald, go out and buy us another twenty-five buck defense bond.

Tell us you were kidding, M'sewer. Tell us that it is a gag as we can hardly refrain from gagging. Don't tell us that you are a Na-a-a-a-az-z-z-z-z-ty ma-a-an! Well, we weren't going to print this communique, Frenchy (?), but we decided that it was our duty. We took a gander at the envelope just now to make sure it was not post-marked in the town where Adolf hides out. We guess we have made comment enough. We will let the readers take care of you, M'sewer.

Ah, a breath of spring strikes against our leathery physiognomy and purifies the air in the hangar. Miss Wilma Todd of Ester-ville, Iowa, airs her opinion of our magazine thusly:

I'm going to tell you what I think of your magazine—it's wonderful.

I like your stories. They're swell. Only one thing is wrong. Now don't think I'm mushy, but I do like a little romance mixed in. And can't you make our heroes a little handsome? I get tired of a diet of red hair—green or gray eyes—iron jaws, etc. That's the only description when we do get one. Sometimes the authors don't even describe our heroes. Anyway, orchids to your authors. Say, I'd like some pen pals—soldiers, marines, navy boys and pilots.

I'm saving my nickels to take flying lessons myself even though I am a female. I also would like pen pals from Texas and Western states. I've been told I am pretty, and I'm the school drum-major-ette. I'll exchange snapshots with my pen pals. I'm fifteen, with blue eyes and brunette hair. So there's an idea of what I look like. And, Wing Commander, if you don't print this I'll cut off your ears and fry 'em for supper—if they are clean.

Don't crowd now. Just everybody get hold of themselves. We are particular as to just the type we will allow Wilma to correspond with as she is a drum-major-ette and only fifteen. We guess Wilma wants the big strong silent type as she said she prefers them west of Ol' Miss. We will advise the authors to lift the ugly pans of some of their heroes, Wilma. As for our ears, they are no little rose petals and a shark would have to take two bites before he had all of one of them. We are not listed as a pen pal, Wilma, but we save snapshots. Huh?

No stranger gives out with this lengthy day letter. Our old pal and severest critic, Richard Papin, who never gives us the

same address twice, wants everybody to mull over the following:

I'm warning you! If you turn out another story like "Pastry Doughboys" you'll hear from my solicitors.

I ran to the bookshop, with my tongue hanging out just waiting to read the latest "Ambrose Hooley."

Believe me, I think your stories are tops, and I really get a laugh out of them. So I am just warning you not to let it happen again.

I have another bone to pick with THE AMERICAN EAGLE. I am getting to like Masters less and less. The guy is just not human. Why in thunder doesn't Morgan make Masters a little real. I was reading the life of one of the World War Aces and he said he never went into a fight that he wasn't scared. At least make John Masters a little nervous. I am sure the stories would be much better if it had some human element.

I would like to hear more about Warren in THE AMERICAN EAGLE. He sounds like a right guy.

"Bombs With Wings" had that old ending, you know, back with the squadron, a few swigs of something or other. Everybody's happy. Phooey! "The Payoff" was blah. "Furtive Skies" was at least different.

One thing I do go for, however, is Around the Hangar, and I also think L. E. A. Flying Course is fair.

It seems like THE AMERICAN EAGLE stories are getting shorter and shorter. Why can't they be at least eighty pages?

I happened to run across an old copy of your mag. Sure enough, it was the same old Masters. At the last minute he grabs a plane and escapes from the enemy drome. Why not have part of his escape on foot across enemy held land. Possibly a chase in a stolen car. Anything to be original.

Now lastly, why do you have so much advertising in the mag? You have almost twenty pages of it that could be used for stories.

Look Richard, we have had trouble with you before. Why not try and be a pal? We try to do the best we can with what pay we get and all. What is the reason you can buy a newspaper for three cents when it costs about four times that much per copy to print? Advertising, my boy. Think it over, Dick. Give Morgan a chance to clean the spark plugs in his mental assembly and he'll make you like Masters. But we are always glad to hear from you.

From Wilfred E. Mis of 19 Walnut St., Chicopee Falls, Mass., comes this reminder. We have an explanation, an alibi to offer Wilfred after we let you in on what he has to say here:

I was really disappointed when I learned that my letter wasn't printed in the last issue of THE AMERICAN EAGLE. I still have here, on my desk, your letter of March 7, in which you said that you were going to publish my letter in your next issue. I hope I will see my letter then.

We apologize, son. The long letter we received from you last May, wherein you related your experiences in Warsaw during the blitz, was mislaid.

However, here is the story, Wilfred. For the life of us, and our poor old eyes are not what they used to be, we could not read more than a few lines of your contribution and we put it aside fully intending to get someone to figure it out for us. Here is what we want from you, Wilf. Could you get a letter to us, type-written, and have it follow the tempo of the last one as near as possible? We will expect it, yes?

Keep writing, pal.  
We must get on. From J. W. Pruett, a potential Rhett Butler of 1404 Christine

[Turn page]

# TIGHTENS FALSE TEETH or No Cost!

JIM WON'T EAT OUT BECAUSE HE LOSES HIS FALSE TEETH

BOB NEVER HAS PLATE TROUBLE

RUTH SAYS BOB NEVER HAS PLATE TROUBLE

I'LL ASK HIM FOR HIS SECRET

BOB, HOW DO YOU KEEP YOUR PLATE FROM SLIPPING?

CINCH! A SQUEEZE OF CROWN RELINER KEEPS 'EM TIGHT!



### OUR AMAZING OFFER

Don't suffer embarrassment and discomfort caused by loose dental plates. Apply CROWN RELINER. In a lily your plate fits like new and stays that way up to 4 months. No old fashioned heating to burn your mouth. Just squeeze CROWN from tube and put your teeth back in. They'll fit as snugly as ever. Inventor is a recognized authority in dental field. A patent has been applied for CROWN RELINER to protect you from imitators. After you reline your plate with CROWN, take your false teeth out for cleaning without affecting the CROWN RELINER. CROWN RELINER is guaranteed . . . it's harmless. NOT A POWDER OR PASTE! If not satisfied, even after 4 months, return partly used tube for full refund.



Order this



this FREE



J. Clements of Algonac writes: "My plates were so bad they rattled when I talked." "Now I can eat steaks or corn on the cob." "Reline your plate with CROWN. It's tasteless. Has that natural pink color. Order a tube of CROWN RELINER today . . . enough to last a year. We include FREE a tube of CROWN plate cleaner. SEND NO MONEY. Just send name and address. Pay postman \$1.00 for combination, plus postage, or send cash and we pay postage. Act at once and enjoy this new happiness."  
**CROWN PLASTICS CO., Dept. 2312**  
4358 W. Philadelphia Ave., Detroit, Mich.



Send NO MONEY

## GLASSES by MAIL

\$2.95

up

COMPLETE

NEWEST STYLES

We GUARANTEE SATISFACTION

or MONEY-BACK

16 DAYS'

TRIAL

FREE

Catalog and Information WRITE TODAY!

BROKEN GLASSES REPAIRED

U. S. EYE-GLASSES CO., Dept. C-82

1557 MILWAUKEE AVENUE, CHICAGO, ILL.

## ROLLS DEVELOPED

25c Coin. Two 5x7 Double Weight Professional Enlargements, 8 Gloss Deckle Edge Prints.  
**CLUB PHOTO SERVICE, Dept. 15, LaCrosse, Wis.**

# SINUS HEAD COLDS CATARRH

TRY THIS FOR RELIEF OF THE NASAL CONGESTION

To ease such nasal congestion symptoms as sniffing, sneezing, hawking, stuffed-up feeling, watery eyes, roaring ears and pounding pressure, FLUSH the nasal passage with SINASIPTEC. Based on a physician's successful prescription. SINASIPTEC washes out thick, crusty, sticky, old mucus as it soothes and reduces swollen, irritated tissue. Ask your druggists.

Send Today for An Amazing 25c Test

Just mail 25c with name, address, today for new special complete Sinasipitec and Muggi Douching package for thorough trial to American Drug Corp., Dept. A1X, 6060 Maple, St. Louis, Mo.

# MOTORISTS Wanted!

## TO MAKE THIS UNIQUE GAS SAVING TEST



**FITS ALL CARS**  
Constructed of six parts fitted into a single point, adjusted and sealed at the factory. Easily and quickly installed by anyone in a few minutes.

Will you permit us to send you at our risk the Vacu-matic, a device which autoowners everywhere are praising? Install it on your car. Test it at our risk. Unless it trims dollars off your gas bills by saving up to 30% on gasoline consumption, gives more power, quicker pickup and faster acceleration, the test will cost you nothing.

**Automatic Supercharge Principle**  
Vacu-matic is entirely different! It operates on the supercharge principle by automatically adding a charge of extra oxygen, drawn free from the outer air into the heart of the gas mixture. It is entirely automatic and allows the motor to "breathe" at the correct time, giving an increase as required. Saves up to 30% on gas bills, with better motor performance.

**AGENTS** *Get 2 Weeks FREE*

**FOR INTRODUCING.** Here's a splendid opportunity for unusual sales and profits. Every car, truck, tractor owner a prospect. Send name and address now for big money making offer and how you can get yours Free. **The Vacu-matic Co., 7617-618 W. State Street, Wauwatosa, Wis.**

## ANY PHOTO ENLARGED

Size 8 x 10 inches or smaller if desired. Same price for full length or bust form, groups, landscapes, pet animals, etc., or enlargements of any part of group picture. Safe return of original photo guaranteed.

**47¢**  
3 for \$1.00



**SEND NO MONEY** Just mail photo or snapshot (any size) and within a week you will receive your beautiful enlargement, guaranteed fadeless. Pay postman 47¢ plus postage—or send 48¢ with order and we pay postage. Big 16x20-inch enlargement sent C. O. D. 79¢ plus postage and send 50¢ and we pay postage. Like enlargements of this amazing offer now. Send your photos today. Specify size wanted. **STANDARD ART STUDIOS, 1138. Jefferson St., Dept. 401-W, Chicago**

## SONG & POEM WRITERS

Have you a song, poem or just a lyric? **WE SUPPLY THE MELODY** and make recordings of your original songs.

Send yours to  
**CINEMA SONG COMPANY, P. O. Box 2828, Dept. B-9, Hollywood, Cal.**

**CRIME DETECTION**  
SECRET SERVICE AND FINGER PRINTS

**SECRET SERVICE BOOK**  
**FREE**

For 30 Days Reading  
No Money Down—Actual Office Cases—  
100 Pages—We will send you this stirring book on Crime Detection, Secret Service and Identification Work for 30 days free reading. Send me money if you desire to keep it, then send me only \$1.00. If not, return it. Write TODAY. Literature sent only to persons stating their age.

**J. G. Cooke, Dept. 7969, 1928 Sunnyside Ave., Chicago, Ill.**

## ASTHMA

TREATMENT mailed on Free Trial. If satisfied send \$1; if not, it's Free. Write me for your treatment today.

**W. K. STERLINE, 836 Ohio Ave., Sidney, Ohio**

## FREE SAMPLES OF REMARKABLE TREATMENT FOR Stomach Ulcers

Due to Gastric Hyperacidity



H. H. Bromley, of Shelburne, Vt., writes: "I suffered for years with acid-stomach trouble. My doctors told me I had acid stomach ulcers and would have to diet the rest of my life. Before taking your treatment I had lost a lot of weight and could eat nothing but soft foods and milk. After taking Von's Tablets, I felt perfectly well, ate almost anything and gained back the weight I had lost." If you suffer from indigestion, gastritis, heartburn, bloating or any other stomach trouble due to gastric hyperacidity, you, too, should try Von's for prompt relief.

Send for FREE Samples of this remarkable treatment and details of trial offer with money back guarantee. Instructive Booklet is included. Write:  
**PHILADELPHIA VON CO. Dept. 138-J**  
Fox Building, Philadelphia, Pa.

Avenue, Anniston, Alabam', we get this nice letter. Give a listen:

Congratulations on the new name for the L. E., but where are the improvements, cover to cover, as stated in the last issue? Just one that I can see, and that's the new plane pictures.

But enough of that, how about dragging some World War II model planes off the shelf and putting them to use? The Spitfire plans were good, so let's have some more of 'em.

And say, what's all this gassing about Masters? Some say have him in the old fight, some the new one, but as for me, I say swap him around; for instance, put him in the new war for one or two months, then in the old for two months. And how about checking up on Masters, seems like he's letting this Fraulein (R-47) get away too much. She ought to be settled once and for all. Trot out a new villain to pester him, and I really mean pester him, I want some rough play for a while.

Well, before I let down my flaps and smack the carpet, I want Masters ferried back across the briny to England's war. The war over here isn't so hot. What war?

We aim to please, J. W. In a few shakes we will get Lieut. Morgan on the carpet and ask him can he arrange some homicide regarding R-47. We'll try to improve the magazine further for you—one of these days you'll notice how much progress we've made.

But we must move along as this is the age of speed and priorities, isn't it? Before us is the next despatch from the Sooner State. A card from George Megill, Box 93, Granite, Oklahoma. Georgie suggests:

- 1—Show in your illustrations and have in your stories pilots using new American planes sent to Britain on the Lend Lease Bill.
- 2—Have a few World War I stories.

Your card received and contents noted, George. Just leave the rest to us, as the sprouts said when the old man cut the first slice out of a layer cake. Getting on with more serious affairs, let us have a gander at that fat one you are musing up, Oswald. Give it here. It is from a familiar citizen. Dale Baxter, Capt., S.C.C. Dale gets under the sheets at 1101 West St., Gary, Indiana. His four sheets tell us:

I am sending in my application for membership card, and combination card case and looseleaf memo book.

I wish to become a member of the Pen Pal Club. I will answer all letters received. In case you or anyone else would like to know, I am seventeen years old, five feet six inches tall, and strain the scales at one hundred forty pounds. Light brown hair with one wave in front; blue eyes and interested in everything.

This is the first time that I have ever read THE AMERICAN EAGLE. I was surprised after I had read "Wings of Treason" by Lieut. Scott Morgan. I had read several other stories in different books, THE AMERICAN EAGLE is the best so far. It does not follow the same old style that a lot of books use. Your stories are interesting and are kept moving by just the right amount of action all the way from the beginning to the end. I do hope that we have as good a story next issue as we had this issue.

If you want to keep me a booster you will have to have at least one World War II story in each book. Modern living must have modern literature, at least that is what I believe. I think that the stories by Joe Archibald rank up with those of Lieut. Scott Morgan. He is a swell author, and it will take some one a long time and a long way to equal his writing.

I think that the article "Around the Hangar" is about the best I have read in a long time. It is interesting for the reader, but I bet a heck of a job for the W. C. Keep up the fine work and the readers

will sure back you up. I only wish it could be made longer.

I am a solid model builder and am I nuts over your scale plans for the Camel this month. I hope they will keep being as good as the one this month. You sure gave detail and that is what all the model builders love. You have a devoted model builder in me, and if I can get more plans for solid jobs I will go crazy with joy.

I noticed that you have a few crabs among your readers. If they gave the book to some one who could understand it and if they read bedtime stories instead maybe they would feel a lot better toward you. Any man who does not like this book must be out of his head. For a dime you cannot equal it and I dare any one to say different. I remain your loyal and true booster of THE AMERICAN EAGLE.

Now, there IS a letter. Dale is a real, patriotic American who realizes the awful strain your C.O. is under as he puts out this department. Understanding guys like Dale are as scarce as teeth in a broody hen's mouth and we hope he lives to be a hundred and eight, no less. But that praise he hands Joe A. Nobody is that good. That little squirt who must have been born under a dresser, cannot stand too much flattery. Throw some water on that butt of a Connecticut stick of broccoli he left in here, Oswald. Thanks, Dale. We have the courage to go on, now. We are not sure how far, though.

Another Sooner? Well, I never. From 912 Lauderdale St., Selma, Oklahoma, we get this one. From Bill Falkenberg.

I have just finished reading "Aces of the Arctic," and it wasn't so very good. At least, it wasn't as good as usual.

I have been reading your air mag three years today. I think it beats all other air mags that I have ever read. I intend to read it as long as it is published.

In your column last month I read where a reader wanted pictures of the last war aces. I must have missed that issue in which something was said about it. Please send or write in your next issue the information for me. By the way, while we are at it, I might add that I think you have a swell column. I always read it before I read the stories.

Please keep Masters in World War II and ship him back to England via fast express.

Such popularity must be deserved. The boss is not going to like this department this month seeing as how we are just coming into our own. He keeps side-stepping us every time he meets us out in the hall, Bill.

For the first time in the history of air books, a carrier pigeon comes from a faithful reader and drops some kernels of corn

[Turn page]

# Getting Up Nights Makes Many Feel Old

Do you feel older than you are or suffer from Getting Up Nights, Backache, Nervousness, Leg Pains, Dizziness, Swollen Ankles, Rheumatic Pains, Burning, scanty or frequent passages! If so, remember that your Kidneys are vital to your health and that these symptoms may be due to non-organic and non-systematic Kidney and Bladder troubles—in such cases CYSLEX (a physician's prescription) usually gives prompt and joyous relief by helping the Kidneys flush out poisonous excess acids and wastes. You have everything to gain and nothing to lose in trying Cystex. An iron-clad guarantee wrapped around each package assures a refund of your money on return of empty package unless fully satisfied. Don't take chances on any Kidney medicine that is not guaranteed. Don't delay. Get Cystex (50c-1.00) from your druggist today. Only 35c. The guarantee protects. Helps Flush Kidneys you.

## Cystex

# FALSE TEETH

LOW AS \$6.85 90 DAYS' TRIAL TEST THEM EXAMINE THEM



We make FALSE TEETH for you by mail from your own impressions. You have satisfaction of MONEY BACK GUARANTEE. Customers in United States and Canada report SATISFACTION but you be your own JUDGE. SEND NO MONEY TO DAY for FREE BOOKLET and MATERIAL. CLEVELAND DENTAL SUPPLY CO. Dept. 2T-7, East St. Louis, Illinois

# INVENTORS

Protect your idea with a Patent. Don't delay. Get Free "Patent Guide." No charge for preliminary information. Write us today. CLARENCE A. O'BRIEN—Registered Patent Attorney 1M8 Adams Building Washington, D. C.

# Free for Asthma During Winter

IF you suffer with those terrible attacks of Asthma when it is cold and damp; if raw, Wintery winds make you choke as if each gasp for breath was the very last; if restful sleep is impossible because of the struggle to breathe; if you feel the disease is slowly wearing your life away, don't fail to send at once to the Frontier Asthma Co. for a free trial of a remarkable method. No matter where you live or whether you have any faith in any remedy under the Sun, send for this free trial. If you have suffered for a lifetime and tried everything you could learn of without relief; even if you are utterly discouraged, do not abandon hope but send today for this free trial. It will cost you nothing. Address: Frontier Asthma Co., 41-J Frontier Bldg., Buffalo, N. Y., 462 Niagara St.

## PIPESMOKER'S BARGAIN

INTRODUCTORY PIPE & TOBACCO OFFER

One of America's finest pipe craftsmen has hand-tooled a large quantity of imported briar pipes. London Thorn, our name for the pipe, represents an extraordinary value—one that you are not likely to duplicate anywhere. It is carved of rare old genuine imported briar. It has a good sized rugged bowl that keeps the pipe cool. It is light and easy to hold. The stem is of genuine Vulcanite Para. It is a sturdy, outdoor pipe that smokes clean, cool, and sweet. The minute you light up your London Thorn with my Lafayette Tobacco, you'll say it's the finest smoke you ever had.

I want you to try my Lafayette Pipe Mixture—a genuine American Blend of the finest domestic tobaccos. Once you have smoked several pipefuls, I know you will say, as have thousands of other Americans, "Lafayette Pipe Mixture is my first choice for a mild, cool, aromatic and slow burning pipe tobacco."

\* Illustrated is 04 shape, also available in all popular shapes. Tell me which you like and let me please you with my expert selection.

**HERE'S MY OFFER!**

LONDON THORN \$1 (worth much more.)  
2 Pkgs. Lafayette Pipe Mixture reg. 40c  
20c ea.

Total \$1.40 value and we pay the postage.

**GUARANTEE:** If you are not completely satisfied return the merchandise and we will refund the money. Simply send one dollar bill, check or money order with your name and address, or if you prefer C. O. D. you pay the postman \$1. plus postage to

**JOHN'S PIPE SHOP • 1133 Broadway • N. Y. C.**

# Learn this Profitable Profession



## in 90 Days at Home

Hundreds of men and women of all ages 18-50 make \$10.00 to \$20.00 in a single day giving scientific Swedish Massage and Hydro-Therapy treatments. There is a big demand from Hospitals, Sanitariums, Clubs, Doctors and private patients as well as opportunities for establishing your own office.

Learn this interesting money-making profession in your own home by mail, through our home study course. Same instructors as in our **NATIONALLY KNOWN** resident school. A diploma is awarded upon completion of the course. Course can be completed in 3 to 4 months. High School training is not necessary. Many earn big money while learning.



## Anatomy Charts & Booklet FREE

Enroll now and we will include uniform coat, medical dictionary, patented reducing roller and Hydro-Therapy supplies without extra cost. The reducing course alone may be worth many times the modest tuition fee.

Send coupon now for Anatomy Charts and booklet containing photographs and letters from successful graduates. These will all be sent postpaid—FREE.

THE College of Swedish Massage  
Dept. 063—38 E. Adams St., Chicago

You may send me FREE and postpaid, Anatomy Charts, booklet containing photographs and letters from graduates, and complete details of your offer.

Name .....

Address .....

City ..... State .....

# SONGWRITERS

We want your song or song poem. Melodies written for songs, poems without charge. We also revise, record and market your song. We have helped others, why not you? Send your song or poem today for free examination and details.

**Hollywood Recording Studios**  
Dept. B15, Box 87, Pross Sta., Los Angeles, Calif.

## ANY BOOK IN PRINT!



Delivered at your door. We pay postage. Standard authors, new books, popular editions, fiction, reference, medical, mechanical children's books, etc.—**ALL AT GUARANTEED SAVINGS.** Send card now for Clarkson's 1942 Catalog.

**FREE** Write for our great illustrated book catalog. A short course in literature. The buying guide of 200,000 book lovers. The answer to your Christmas gift problem. FREE if you write NOW—TODAY!

**CLARKSON PUBLISHING COMPANY**  
Dept. THL, 1253 So. Wabash Ave., Chicago, Ill.

EASY WAY...

## Tints Hair JET BLACK

This remarkable CAKE discovery, TINTZ Jet Black Shampoo, washes out dirt, moss dandruff, grease, grime and safely gives hair a real smooth JET BLACK TINT that fairly glows with life and luster. Don't put up with faded dull, burnt, off color hair a minute longer. TINTZ Jet Black Cake works gradual... each shampoo leaves your hair blacker, lovelier, softer, easier to manage. No dyed look. Won't hurt permanents. Full cake \$3c (8 for \$1). TINTZ comes in Jet Black, Light, medium and dark Brown, Titan, and Blonde. Order today! State shade wanted.



**SEND NO MONEY** Just pay postman plus postage on our positive assurance of satisfaction in 7 days or your money back. (We Pay Postage if remittance comes with order. I Don't wait—Write today to TINTZ COMPANY, Dept. 703, 207 N. MICHIGAN, CHICAGO. CANADIAN OFFICE, Dept. 703, 22 COLLEGE STREET, TORONTO.

and a letter in our lap. Bob Riswold, no address at hand, wants us to know that he feels sorry for Oswald here. Listen to this despatch from Rooters:

I just got through, thank heaven, reading your mag, and it's actually good. Miracles still happen. I have been building models since I was five, and they still look crummy. I am fourteen years old, five feet nine inches tall, and I weigh one hundred thirty-two pounds. I have brown eyes and brown hair. I like your model plans and could you put in a plan for a Class A gas job? Don't make it too hard. My sympathy to Oswald. I am shedding tears of joy over the poor bum. Please put me in with the pen pals and I promise to answer every letter. When you receive this kindly wind up the carrier pigeon and send him home.

Nice stint, Bob. The pigeon is on its way back after a very good feed of cracka-jacks and salted peanuts. We told Oswald not to feed him the goobers. Trust your old C.O. to see that you get what you want in this hangar. A very short burst gets to us from Fred C. Beck, 5 Wilst Avenue, Hillsdale, N. J. Freddie says a lot in a hurry. As:

Find enclosed sixty cents for which please send me a year's subscription to that swell magazine, THE AMERICAN EAGLE. Thanks for the novel, short stories and flying features. They're tops.

We can rev up too, Fred. Your mag will be sent to you promptly. Merci for the compliments. Save us some more of them as they work on us better than vitamin K.

Quiet. An S.O.S. is coming through on our amateur telegraph set in the washroom there. Copy the dots and dashes down and don't sign your name on the dots, Oswald. What does it say? Oh, this:

Since I last wrote you, not one person has written me. Maybe it's an omen of bad luck to correspond with people. Anyway, it sure seems like it.

**CALLING ALL PEN PALS! CALLING ALL PEN PALS!** Raymond Richter, 102 Hastings Avenue, Upper Darby, Pa., would like very much to have a bunch of pen pals. So, come on, all you drawbacks out there; get your pens and write me.

You know now I have not a single pen pal!!! I lost my only one two months ago when he failed to write me any more!

This can't go on forever. Due to the foreign crisis I should think more American boys would correspond with each other.

That's telling them, pal. We bet this will get results from the correspondents, Ray. We're rooting for you as the two big porkers said to their pal who had his snout put out of order by poison ivy. Come on, write to Raymond. Oswald, never mind that one about the traveling salesman and the farmer's daughter as here is a lady. Lillian Moon wants to be heard from 177 Carolina Ave., Irvington, N. J. Lillian lilts:

During a two weeks' sojourn at the seashore I was introduced to your very fine magazine, THE AMERICAN EAGLE.

It happened that my mother's cousin was at the shore at the same time and he is a rabid airplane fan. He reads every air magazine that he can get his hands on.

I read all the magazines he purchased while at the shore, and particularly enjoyed THE AMERICAN EAGLE.

I am seventeen and would like to be listed as a pen pal. I promise to answer every letter I receive.

I am enclosing a self-addressed stamped envelope for a membership card.

Seventeen? Well, they will get up to thirty or thirty-five yet so your Old Man

[Turn to page 110]



# PEN PALS



Here are some new members of **THE LONE EAGLES OF AMERICA**—all air fans. Many others will be listed in the next issue. The figures in parentheses are the ages of the members.

- Glendell Robinson (14), Oblong, Ill.  
 Delores Vilimek (16), 5216 S. Laramie Ave, Chicago.  
 Hester House (16), Bunker Route, Texas.  
 Irving Lipsiner (14) 2 Roosevelt Ave., Poughkeepsie, N. Y.  
 Eldith Hampton (14), R. D. 2, Box 416, Miami, Fla.  
 James Londergan (16), 25 Melville St., Pittsfield, Mass.  
 Ed Cavin (17), Star Route, LaPine, Ore.  
 Gus J. Szuedo (22), 829A Baugh Ave., E. St. Louis, Illinois.  
 Lt. T. A. Cotter, U. S. N. (27), 6958 Schubert St., Chicago, Ill.  
 Bud Willis (12), 140 East Maine St., Washington, North Carolina.  
 Francis Matsinger (15), 1204 So. 2nd St., Philadelphia, Pa.  
 Willis J. Skidmore (16), 1037-78th St., Brooklyn, New York.  
 Gordon Lund (15), Franklin, Minn.  
 Stanley Queller (16), 1745 Eastburn Ave., N. Y. C.  
 Dick Gates, 9120 Grant Ave., Brookfield, Ill.  
 Bill Thompson, Box 415, Orland, Calif.  
 Granville Cushing Fairchild, Chandler & Harris Roads, Chestnut Hill, P. O. Pa.  
 Richard E. Cosgrove (17), 24 Elmer St., Brockton, Massachusetts.  
 Leland Skonnord (15), 1509-17th St., Fargo, N. D.  
 Margaret Attenberger, Morris St. Limits, Fond du Lac, Wis.  
 Pvt. Ben M. Smither (22), Induction Station, Ft. Thomas, Ky.  
 Richard Skuse (16), 107 East Limerston Road, Rochester, N. Y.  
 Carl Fuglestad (13), 28 Brentwood Ave., N. Y. C.  
 Joe Stubbins (18), Valier, Ill.  
 Marvin Albinak (13), 14216 Freeland, Detroit, Mich.  
 James Hopper (14), 4146 Berkley, Chicago, Ill.  
 Fleming Brown (15), N. Highland Ave., Glen Ellyn, Illinois.  
 John Honig (17), 1237 York Ave., New York City.  
 Mickey Haggard (15), Gen. Del. Mt. Pleasant, Tex.  
 Clarence Roloff (14), Box 155, Amasa, Mich.  
 Peter Starin (13), 138 Madison Ave., Clifton, N. J.  
 Herb Hathaway (14), 5006 Cortland, Chicago, Ill.  
 Byford Sealy (15), Box 16, Andrews, Texas.  
 Jerry Marlon, Blountville, Tenn.  
 Clarence Schloffer (15), R. F. D. 2, Belle Center, O.  
 Earl Cech (15), 1925-56th Court, Cicero, Ill.  
 Jerry Young (14), 47 E. William St., Corning, N. Y.

# BLEEDING GUMS TRENCH-MOUTH MOUTH INFECTIONS

Bad enough to themselves but some of them may lead to other infections, such as:

## PYORRHEA



If you are a sufferer from any of these mouth infections, why not try PY-RO, a simple home remedy which has been used with beneficial results many times.

If your gums bleed . . . if there is evidence of pus . . . or your teeth are loose, give PY-RO a trial and see for yourself if it does not give you the aid you are seeking.

We have on file numerous letters from grateful persons who have used PY-RO, evidencing the improvement of gum infections and of the satisfactory results obtained.

**Order today -- Send no money!**

### USE PYRO!

We believe that PY-RO will quickly convince you of its ability to help correct any of the above conditions from which you believe you are suffering. **DO NOT DELAY!** Send \$2.00 and we pay postage, or pay postman \$2.00 plus C.O.D. charges. Use PY-RO as directed and if not entirely satisfied with the results, we will gladly refund the purchase price in full.

**ORALENE, Inc., Dept. 812**  
 501 West 139th Street New York City, N. Y.



## MAKE THIS MAN SMILE!

*Prove to Yourself You Can Learn to Draw*

### LEARN TO BE AN ARTIST

BY SPARE-TIME TRAINING

Trained artists are capable of earning \$30, \$50, \$75 a week. Prepare for an Art career through our practical, proven method—prepare at home in your spare time. **COMMERCIAL ART, ILLUSTRATING, CARTOONING** all in one complete course. Write for **FREE BOOKLET**, "Art for Pleasure and Profit"—tells all about our method and opportunities in art. **TWO ARTISTS' OUTFITS** with training. Mail postcard for full particulars. No obligation. State age.

**WASHINGTON SCHOOL OF ART, Studio 6612T**  
 1115-15th Street, N. W. Washington, D. C.

# WORK FOR "UNCLE SAM"

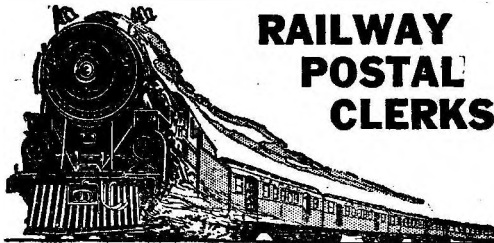

## RAILWAY POSTAL CLERKS

City and Rural Carriers—Postoffice Clerks—  
 Messengers—Accountants—Stenographers—  
 Typists—Many other Government Jobs.

**\$1260 to \$2100 First Year**

**Mail Coupon Before You Lose It**

**FRANKLIN INSTITUTE, Dept. C258,**  
 Rochester, N. Y.

Sirs: Rush to me, without charge, copy of 32-page book, "How to Get a U. S. Government Job," list of positions, and full particulars telling how to qualify for them.

Name .....

Address .....



# FREE BOOK ON RECTAL AILMENTS

Here is good news. A new 122-page, up-to-the-minute book on Piles, Fistula and other related rectal and colon ailments — will be sent free for the asking. It may save you much suffering, as well as time and money. Write today — naming ailments — to The McCleary Clinic, 1297 Elms Blvd., Excelsior Springs, Mo.



## WE MATCH PANTS

### To Any Suit!

Double the life of your coat and vest with correctly matched pants. **100,000 patterns.** Every pair hand tailored to your measure. Our match suit FREE for your O. K. before pants are made. Fit guaranteed. Send piece of cloth or vest today.

**SUPERIOR MATCH PANTS COMPANY**  
209 S. State St. Dept. 276, Chicago



## DICE. CARDS.

Specialties for Magicians use. Inks, Shiners, Check-Cop, Daubs. Catalog ten cents, stamps or coin.  
**HILL BROS., Box T, Salida, Colo.**

## SPECIAL WORK FOR MARRIED WOMEN

Earn up to \$23.00 weekly and your own dresses Free. No canvassing, no investment. Full or part time. Write fully, giving age, dress size.  
**FASHION FROCKS, Inc., Dept. 26042, Cincinnati, O.**

## Quit Using Tobacco!

Write for Free Booklet and Learn How. Results Guaranteed or Money Refunded.  
**THE NEWELL COMPANY**  
405 Clayton Station St. Louis, Mo.

**100,000  
Satisfied  
Users**

## She Got \$400<sup>00</sup> for a Half Dollar

*I will pay CASH for  
OLD COINS, BILLS and STAMPS*

**POST YOURSELF! It pays!**  
I paid \$400.00 to Mrs. Dowty of Texas, for one Half Dollar;  
J.D. Martinez of Virginia \$200.00 for a single Copper Cent. Mr. Manning of New York, \$2,500.00 for one Silver Dollar. Mrs. G.E. Adams, Ohio, received \$740.00 for a few old coins. I will pay big prices for all kinds of old coins, medals, bills and stamps.

**I WILL PAY \$100.00 FOR A DIME!**  
1864 S. Mint; \$50.00 for 1913 Liberty Head Nickel (not Buffalo) and hundreds of other amazing prices for coins. Send 4c for Large Illustrated Coin Folder and further particulars. It may mean much profit to you. Write today to  
**B. MAX MEHL, 133 Mehl Bldg., FORT WORTH, TEXAS**  
Largest Rare Coin Establishment in U. S.

## Stories of British Pilots in Action

in

# R A F ACES

Now on Sale 10c At All Stands

won't give up. Nice bit of penmanship. We took a course in reading character in peoples' writing once. In yours we see you are sympathetic and love all kinds of dumb animals. Oswald could qualify as a pen pal, then. We are kidding, Lillian. This looks harmless. And it is. Harold "Nose-dive" Redbern of 1462 E. 118th St., Cleveland, Ohio, throws his hat into the ring and look what we found tucked into the band:

So Horace has been missing since last week, huh? It's just like that floor-flusher to take a vacation. He probably won't show up for a couple of weeks or so yet.

By the way, tell Lieut. Scott Morgan to keep up the good work. Especially stories like "Wings of Treason." I like John Masters better in World War I stories. How about it?

Please find enclosed my enrollment blank and also list me as a pen pal. I am fifteen years old. Thanks.

Yours till Hitler gets a haircut and tell Oswald I said hello and give Ambrose Hooley my regards.

As you will know after reading the minutes of this meeting, Horace is back and is out there now nibbling on a juicy old tennis shoe. Morgan just stepped in and peered over our shoulder and he says for us to send you his regards. Nobody knows where Muley or Ambrose are, Harold. If they wire in from the Galapagos or somewhere, we will send them your message. Ha, we liked the following opus. Gus Szuedo, no address at our elbow, advises us bluntly:

I like the World War stories much more than the modern ones. They have always been more exciting than modern stories and I would like to see more of them. Above all, please leave out women and romance. They are the destruction of good fighting stories.

Tsk. The girls won't like you, Gus. Your credentials and paraphernalia should be in your possession as you read this. If not, there will be a shake-up around here, pal. Maybe you have reasons regarding the pinafores. Who knows? An itinerant reader (that means one who jumps from place to place, dopes) named Jerry Marion and who hails from Blountville, Tenn., at present, but who intends to move his reticule to 959 Government St., Mobile, Alabama, gives us the stuff we like to get and this is it:

I just finished reading your October edition and I enjoyed it immensely. From now I am going to buy it every month along with your other mag, SKY FIGHTERS, of which I have read several copies and liked them very much.

Lieut. Scott Morgan was tops with "Convoy Blitz." Tell him to keep up the good work. Ambrose Hooley was a wow. I'd like it more if it was about the present war. Please don't make J. Masters go back to World War I. Hoping that the A. B.'s next novel will be even more exciting than it was this month, I'll go back and read the October issue all over again.

You rate a reserved seat in the hangar if you ever get to visit us, Jerry. Isn't one war enough for Muley Spink to go through with Ambrose? Good luck in Mobile, son. What was it we used to sing about Mobile? The birds fly high, or something—what did you say, Oswald? Oh, yeah, I better forget it. So pass us another letter. Bill Smith, who hears the alarm clock go off every morning at 102 S. Richmond St., Villa Grove, Illinois, is another customer

who thinks the dealer is right some of the time. Bill gets this one off his chest:

I have just finished reading the August issue of THE AMERICAN EAGLE. Although this is just the second issue I have read, I for one will not stop reading them.

I agree with boys and girls who want the stories of John Master and his enemies to be in World War No. II. This war today is fought with modern things that would give boys an idea of how the airmen fight in planes.

Now we know we won't be afraid to look the boss straight in the eye as we pass on the tarmac. The big tomato gave us just two months in this outfit, Bill. We welcome you as part of our splendid and most practical organization and know you will live up to the great tradition of the club. Now here is a penny post-card from Jerry Donahue, 112 East Second St., Mesa, Arizona. How are yuh, pardner? Stick your face into this bunkhouse and tell 'em what is on your mind, Jim. Here is what is:

I have been buying your magazine for over a year and I think they are swell. I like the new name better than the old.

Above all keep the World War plans coming. I look forward to them every two months. (I wish it were monthly.) Why not?

Brevity, and how! If you can get hold of a side-winder or a gila monster, we wish you would ship it to us collect, Jim. We would like to send a Xmas present to M'sewer Le Commer. You pronounce it like "coma." Until then, thanks no end.

Oswald Klipspringer, D.S.C., Crow de Guerre, V.C., B.P.O.E., I.O.O.F., whispers in our bad ear as he hands us this one. "A mystery, pal," says Oswald. "An' the writers will go nuts with this one."

We snatch the mysterious manuscript from Oswald and give it to you verbatim:

I am not a member of the The American Eagle Club, so I am writing as a stranger. The American Eagle and Hooley are swell. But I still think the magazine should have a new name such as The American Vulnures. Why? Because the way some of the pen pals heckle you. If they don't like the stories, why don't they write some? Say, that isn't a bad idea, let some of the American Eagle members write stories for the magazine. I think it would increase the membership of the club. Please print this and ask the members about it. Let them answer in the magazine. Some day I may tell you who I am, but now I'll just remain a mystery. My friends even think I am.

I'll be waiting for your answer in the next issue.

So you are a mystery even to your pals? You and Oswald should get together and go out haunting houses as a side-line. But we like you, whoever you are and wherever you live in Cleveland. Say, what is wrong with the Indians?

Seven o'clock? We have got to get out of here as at nine, we have to arrive at a dinner in Phenicia, N. Y., where we are invited to speak to the Order of Moose on the way the U. S. flyers operated in the last guerre. We have to tell about our part in it and show our wounds. It is okay as it is stag.

Our club is growing out of its original pair of rompers and is getting to be a great big power for good in this world and don't you believe the world doesn't need it. We were especially gratified this month by the improvement in discipline and the appreciation of our humble efforts. Of

[Turn page]

# DRAFTING

**BOOKS SENT FREE!**  
**ON APPROVAL—5 VOLUMES**  
**BRAND NEW EDITION**

## For Beginners or Experts

Written so you can understand every word, by well known engineers, De Luxe modernistic, washable cloth binding; over 1600 pages, hundreds of blueprints, charts and diagrams; prepares you for a good drafting job in mechanical lines. Sent for 10 days free use of your mail coupon immediately.

Only 15 minutes a day with these WONDER BOOKS can prepare you for a good drafting job. Drafting from simple straight lines to important complex plans. A step at a time! Built especially for beginners; for men with only grammar schooling. Drafting room practice, PLUS ENGINEERING, made easy and clear. 400 pages on tool design, over 300 pages on machine design. Includes special volume on blueprint reading with full size actual production blueprints, some 20"x30", as well as question and answer sheets.

## Big Field • Big Demand • Big Pay

Competent draftsmen are urgently needed in all manufacturing lines at \$30.00 to \$75.00 a week. That's just the beginning—FOR DRAFTSMEN HAVE GOOD CHANCES FOR ADVANCEMENT. Pleasant, fascinating work, easy to learn and do. Learn quickly with these books—send coupon for a set and see for yourself.

*A year's consulting service now given to all buyers of this famous cyclopedia of drafting.*

**AMERICAN TECHNICAL SOCIETY**  
**Publishers—Home Study Courses**

American Technical Society, Dept. D949, Drexel at 58th St., Chicago, Ill. Send for 10 days' free trial of "Encyclopedia of Machine Trades." I will pay the delivery charges only. If I wish, I may return books in 10 days and owe you nothing, but if I decide to keep them, I will send \$2.00 after 10 days, then only \$3.00 a month thereafter until \$10.00 the total price, is paid. Send Brand New edition and include Consulting Service Certificate.

Name.....

Address.....  
Please attach letter stating age, occupation, employer's name and address and that of at least one business man as a reference.

## MAKE MORE MONEY

**Taking Orders for the NIMROD Line**

Earn more every day in the year representing old established firm with a complete line of fast selling necessities: Shirts, Ties, Underwear, Hosiery, Pajamas, Raincoats, Sweaters, Leather Jackets, Campus Coats, Pants, Hats, Braces, Shoes, Uniforms, etc. Every item guaranteed. Experience unnecessary.

Write quick for FREE SALES EQUIPMENT

**NIMROD COMPANY,**  
4922-J Lincoln Ave., Chicago, Ill.



## SONG POEM WRITERS

Write today for free Booklet outlining profit sharing plan.

**ALLIED MUSIC**  
Dept. 32, 7608 Reading, Cincinnati, O.

## THE TRUTH ABOUT Stomach Ulcers

**Caused by Gastric Hyperacidity**

**FREE** Booklet on simple home treatment. Many report they were saved from expensive operations. Learn all about this amazing inexpensive home treatment. Pain relieved from the start. No rigid or liquid diet. This valuable booklet sent FREE with information as to guaranteed trial offer.

**TWIN CITY VON CO.,** Dept. 204, Minneapolis, Minn.

## FALSE TEETH

**MONEY RETURNED IF NOT SATISFIED!**

Order by mail—a wide selection of styles. As LOW AS \$6.50 a plate. Your money back if not satisfied.

**90 Days' Wearing Trial**  
Ask for free descriptive circular showing different styles and FREE impression material. Ask about our budget savings plan. Gold crown given with plates No. 2 to No. 8. Write today.

**Ward Dental Lab.,** 938 W. 63 St., Dept. 25M, Chicago

**INDIVIDUALLY Made from YOUR Mouth Impression**

**6<sup>50</sup>**  
**90 Days' Trial Total**

# INDIGESTION

may excite the Heart

Gas trapped in the stomach or gullet may act like a hair-trigger on the heart. The heart is not hurt but it skips and races like mad. At the first sign of distress smart men and women depend on Bell-ans Tablets to set gas free. If the FIRST DOSE doesn't prove Bell-ans better, return bottle to us and receive DOUBLE Money Back. 25c at all druggists.

**NOW a DYNAMIC HEAVY DUTY INDUSTRIAL WELDER**



**WORKS OFF 110-Volt Light Socket.** This marvelous Dynamic Power Welder does the work of much higher priced types. It is RETAIL, easily portable. WELDS Cylinder Blocks, Bumpers, Fenders, Tanks, Farm Machinery, etc. Will also solder and braze on the lightest material. Works on iron, steel, tin, brass, copper and all other metals. Men without previous experience can make as much as \$5.00 on a one-hour repair job. In a year's time a Dynamic Welder COSTS YOU LESS THAN 6 CENTS A DAY

Instructions Free—Open a welding shop now. AGENTS—Make big profits selling to garages, factories, janitors and machine shops. Write today for our 10-DAY TRIAL OFFER. DYNAMIC WELDER COMPANY, 2228-8C SILVERTON ROAD, CHICAGO, ILLINOIS

**USED Correspondence Courses**

Complete home-study courses and educational books, slightly used. Sold, rented, exchanged. All subjects. Money-back guarantee. Cash paid for used courses. Full details and illustrated 72-page bargain catalog FREE. Write today! NELSON CO. 500 Sherman, Dept. M-227, Chicago

**HAND-COLORED in Oil PHOTO ENLARGEMENT**

Beautifully mounted in 7x9 white frame mat. Made from any photograph, snapshot or negative. Original returned. Send 25c and stamp—no other charges. COLORGRAPH, Dept. TF-18, 17 N. LeClaire, Chicago. PLUS 3c STAMP for Mailing

**25c**

**LODESTONE LIVE AND STRONG**

7 Keys to Power, \$1. Postage extra if C.O.D. Charms, Powders, Oils, Herbs, Novelties, etc., described in FREE Catalog. D. SMYTHE CO. Box T, NEWARK, MO.

**Asthma Mucus Loosened First Day For Thousands of Sufferers!**

Choking, gasping, wheezing spasms of Bronchial Asthma ruin sleep and energy. Ingredients in the prescription Mendaee quickly circulate through the blood and commonly help loosen the thick strangling mucus the first day, thus aiding nature in palliating the terrible recurring choking spasms, and in promoting freer breathing and restful sleep. Mendaee is not a smoke, dope, or injection. Just pleasant, tasteless palliating tablets that have helped thousands of sufferers. Printed guarantee with each package—money back unless completely satisfactory. Ask your druggist for Mendaee today. Only 60c.

**READ "The Big Three" in Comics**

**THRILLING COMICS**  
**STARTLING COMICS**  
**EXCITING COMICS**

**Each 10c At All Stands**

course we have to expect to find one crummy prune in a barrel once in a while.

Don't forget to bring Horace in out of the weather, you guys, before you lock up the hangar. Horace lost a lot of weight by getting homesick down South and we must build him up again.

Oswald, you stay here and mop up the floor. It is where you have been sleeping the last two weeks. Well, good night everybody and don't forget to read about my talk to the Moose in tomorrow's papers. Don't forget to put the flaps down.

—THE WING COMMANDER.

**OUR NEXT ISSUE**

NOW that we've all listened to the Wing Commander, it's my turn to put in a word or two—and I'll start by inviting you to join THE LONE EAGLES OF AMERICA at once if you have not yet signed up. It's great fun to belong—and there are no dues or fees. The coupon's below—just sign, clip and mail it in. See page 109 for a partial list of new members.

Everybody—be sure you're on hand for next issue's grand book-length novel, EXILED WINGS. This is the sensational, thrill-a-minute story of the pilots of conquered countries who form a vast organization to win back freedom for their native lands. How they outwit the Nazis time and again, and how John Masters takes a hand in their glorious game, is told in EXILED WINGS—a novel that zooms with action, excitement and patriotic punch from start to finish.

Also—Ambrose Hooley Hawler and many other stories and features. Altogether, a gala issue you will enjoy! See you then—and meantime keep The Wing Commander busy reading your letters and postcards! So long.

—THE EDITOR.

P. S. We still have available several hundred sets of sepia portraits of famous World War aces. Each set contains eleven portraits and is well worth owning. To get your set, send a name-strip from the cover of this magazine—plus 15 cents in stamps or coin to defray mailing and handling costs. OR, if you send name-strips from the covers of any three of the following four magazines—THE AMERICAN EAGLE, SKY FIGHTERS, R A F ACES and AIR WAR—you need only enclose a self-addressed stamped envelope.

**THE AMERICAN EAGLE**  
10 EAST 40th STREET  
NEW YORK CITY

Gentlemen:

Please enroll me as a member of the LONE EAGLES OF AMERICA. I am interested in flying and hereby pledge myself to work for the advancement of aviation.

Name .....

(Print legibly)

Street .....

City and State ..... Age....

Do you want to be listed as Pen Pal?.....  
State whether you are a pilot, can fly, have ridden as passenger, or intend to become a pilot.

.....

Date .....

.....  
(Signature)

**IMPORTANT:** Enclose a stamped, self-addressed envelope if you want a membership identification card.

**IF already a member check here**

Foreign readers are requested to enclose American stamps or International Reply Coupons

12-41